

# YMC

## Biochromatography Columns

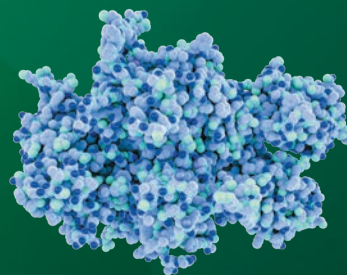

RP  
SEC  
IEX  
HIC

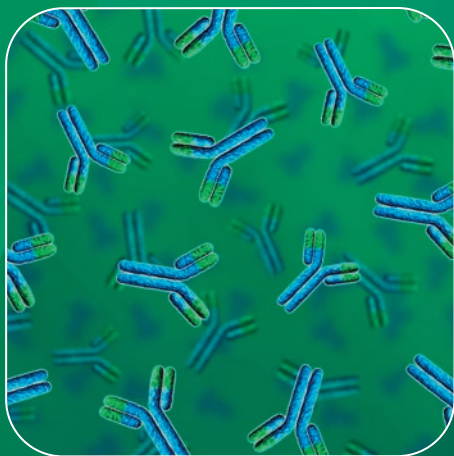

## HPLC Columns for Biochromatography

	Reversed Phase (RP)	Size Exclusion (SEC)	Ion Exchange (IEX)	Hydrophobic Interaction (HIC)
Separation principle	Hydrophobicity	Molecular weight	Electric charge	Hydrophobicity
Max. MW	Up to about 150,000 Da	Up to about 1,000,000 Da	Up to several millions Da	Up to about 1,000,000 Da
Resolution	+++	++	+++	+++
Speed	+++	+	++ / +++	+++
Loading	++	++	+++	+++
Stability	+ / ++	+++	+++	+++
Usage (e.g.)	<ul style="list-style-type: none"> <li>• Peptide mapping</li> <li>• LC/MS</li> <li>• Nucleic acids and oligonucleotides</li> </ul>	<ul style="list-style-type: none"> <li>• Impurity analysis of antibody-drug conjugates</li> <li>• MAb separation</li> </ul>	<ul style="list-style-type: none"> <li>• Proteins/MAb</li> <li>• Charge variant analysis</li> <li>• Isoform analysis</li> <li>• Nucleic acids and oligonucleotides</li> </ul>	<ul style="list-style-type: none"> <li>• Drug-binding analysis of antibody-drug conjugates</li> </ul>

Application data mainly by courtesy of YMC Co., Ltd.

The following brands, trademarks, or service marks are the property of the listed company and/or its subsidiaries.

XBridge Protein BEH, XBridge Peptide BEH are trademarks of Waters Corp.

Aeris is a trademark of Phenomenex, Inc.

Pro Pac WCX-10, MabPac HIC-10 are trademarks of Thermo Fisher Scientific.

Advance Bio RP-mAb is a trademark of Agilent Technologies, Inc.

TSKgel SuperSW3000, TSKgel BioAssist Q/S, TSKgel SP-NPR, TSKgel Butyl-NPR are trademarks of Tosoh Corp.

GE Healthcare Mono Q/S is a trademark of GE Corp.

Every effort has been taken to ensure this list is accurate at the time of printing this brochure.

	<b>Page</b>
Phase selection guide.....	04–05
Method Validation Kits for BioLC.....	06
<b>BioLC applications.....</b>	<b>07–20</b>
Antibodies/ADCs.....	08–14
Proteins/Peptides.....	15–17
Oligonucleotides/Plasmids.....	18–20
Reversed Phase (RP).....	21–40
Size Exclusion (SEC).....	41–50
Ion Exchange (IEX).....	51–62
Hydrophobic Interaction (HIC).....	63–72
Substance index.....	74–75

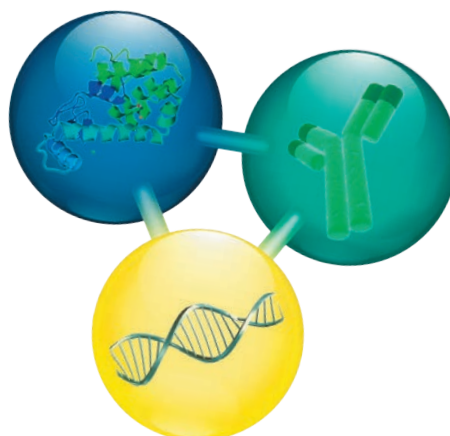



## Proteins / Peptides

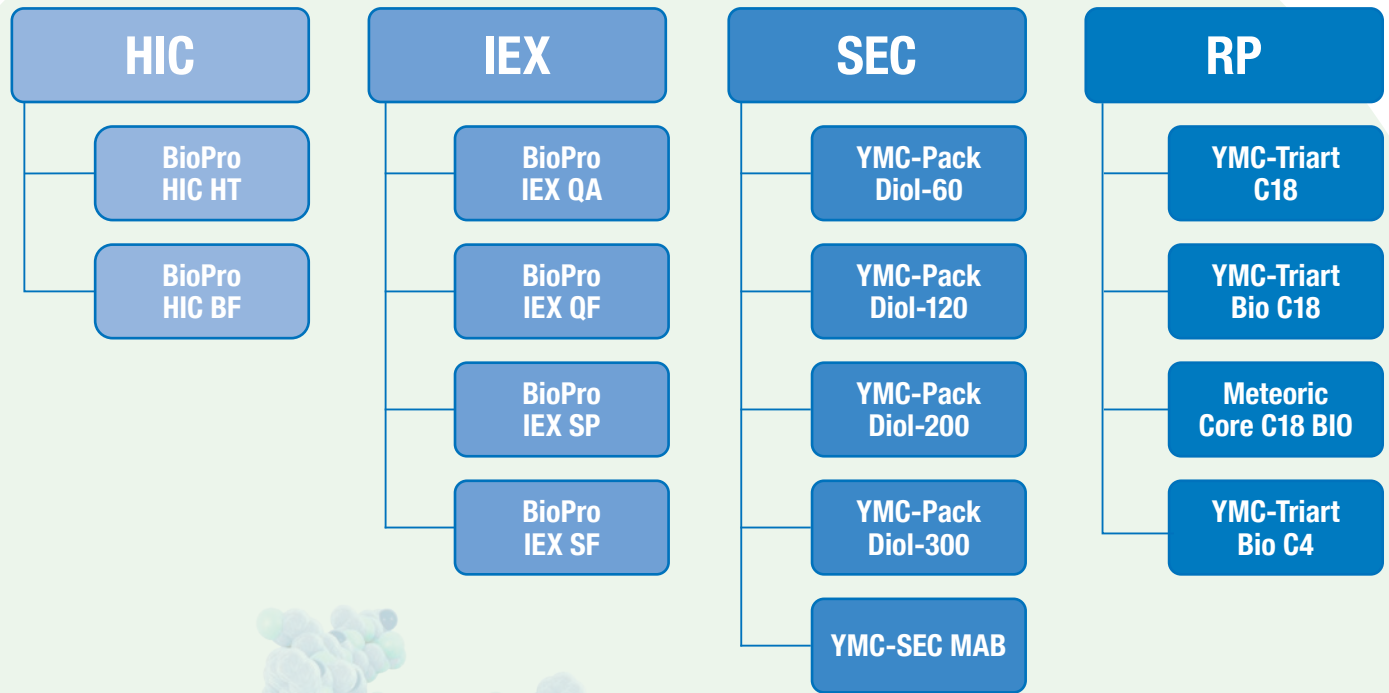

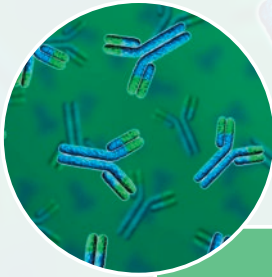

### (Monoclonal) Antibodies

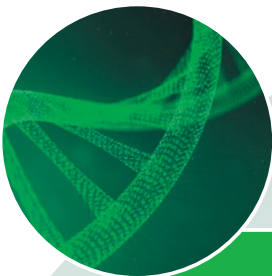
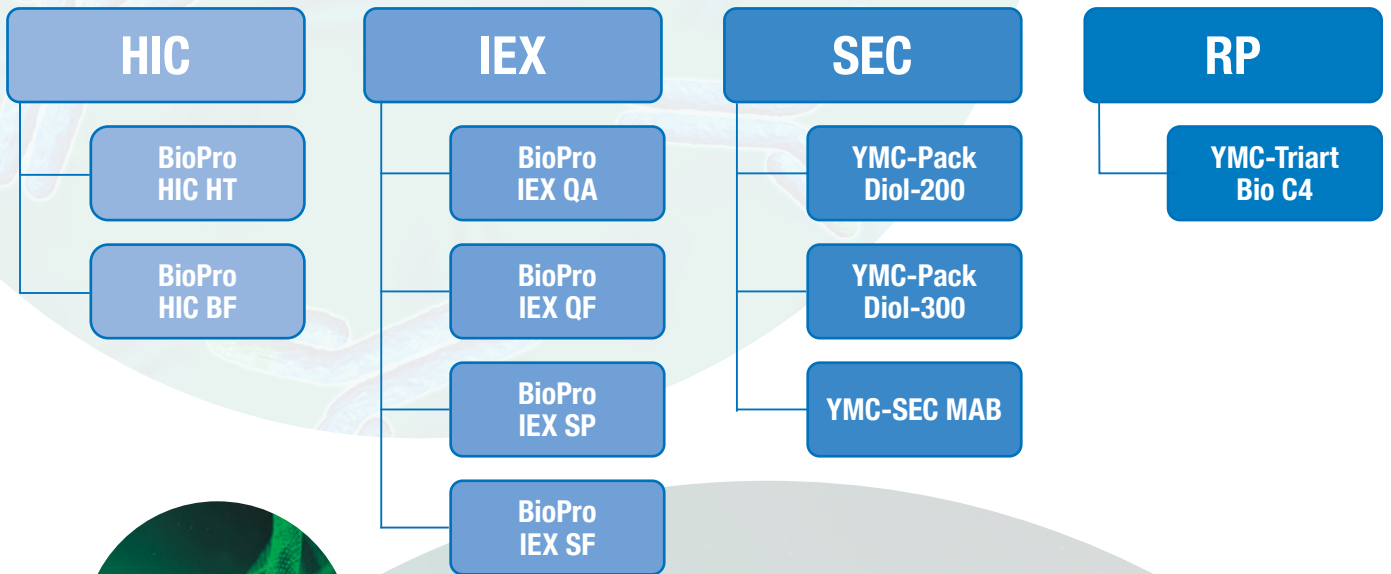

### Oligonucleotides / Nucleic Acids

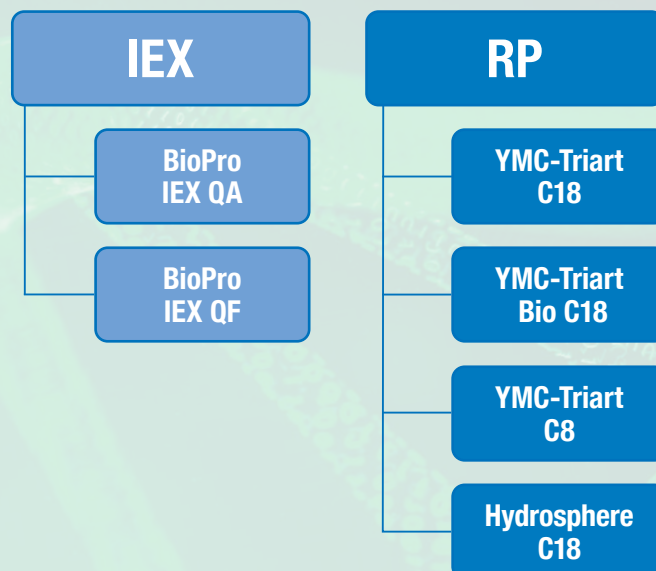

## Bio QC – Validation kit

### Method Validation Kits for BioLC

- for documentation of robustness and reproducibility
- three analytical columns from specified lots

#### Validation kit:

contains three analytical columns packed with stationary phases from three different batches, in order to solely test the robustness of the particular method.

#### Available dimensions:

Length: 30 or 33, 50, 75, 100, 150, 250, 300 mm

ID: 2.0 or 2.1, 3.0, 4.0, 4.6, 8.0 mm

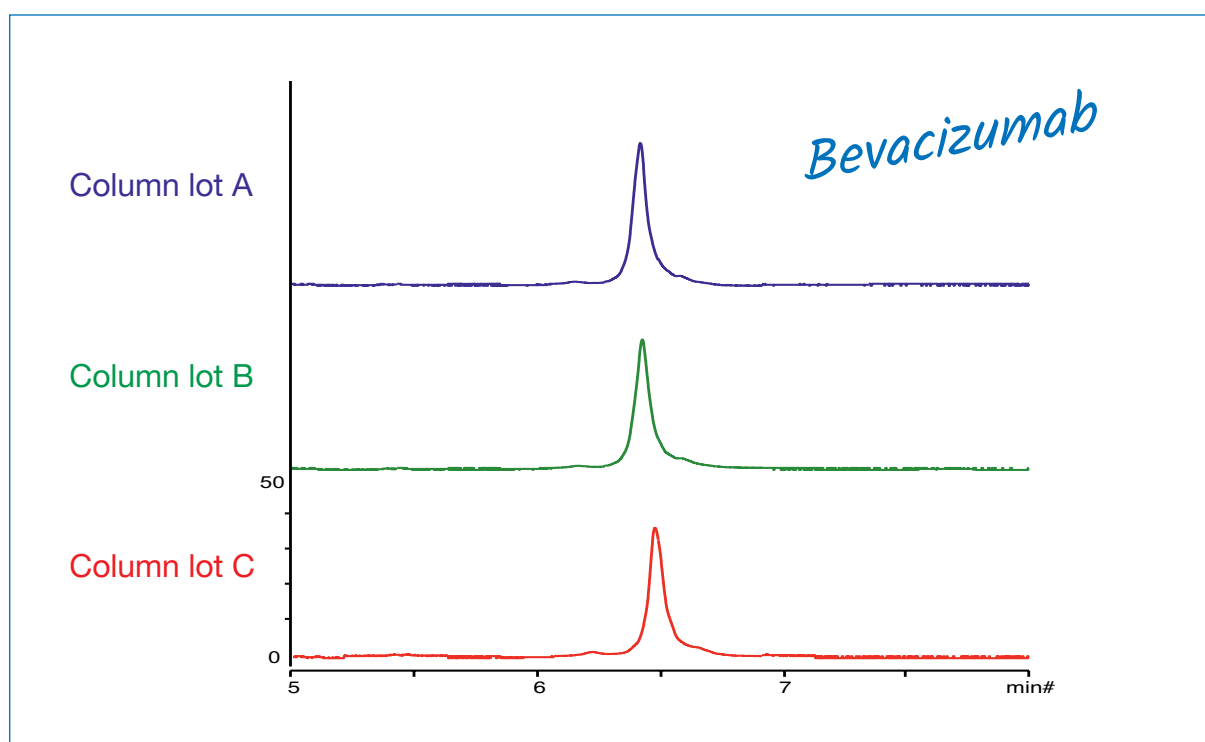

To order a validation kit simply use the ordering number for the column of interest, e.g. **TB30SP9-05Q1PT** and add V1: **TB30SP9-05Q1PTV1**.

For details on YMC selectivities and the International Product Code please refer to the specific product sections in this catalogue.

### Batch Reservation Service

Occasionally, a critical analytical method may not prove as robust as you would prefer. Columns from a particular media batch may be the only way that you can, for example, isolate a critical process impurity. In such cases, YMC will reserve a specific batch of material for the use of an individual customer. YMC will also reserve prepacked columns for release according to a pre-arranged schedule.

**Please call YMC or contact your YMC representative for details.**



BioLC  
Applications

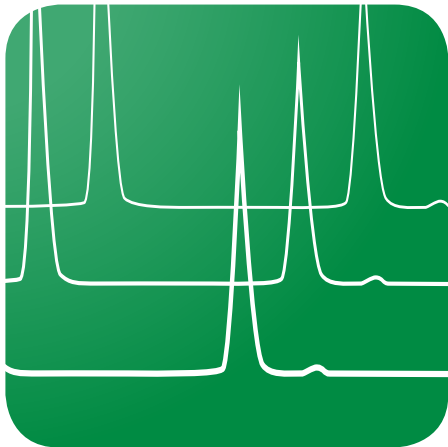
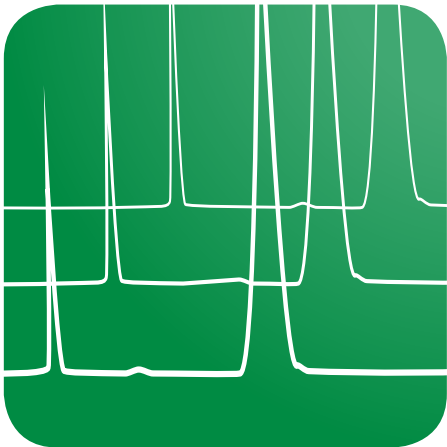

# BioLC applications – Antibodies

## Bevacizumab and its fragments and aggregates

3.4 MPa

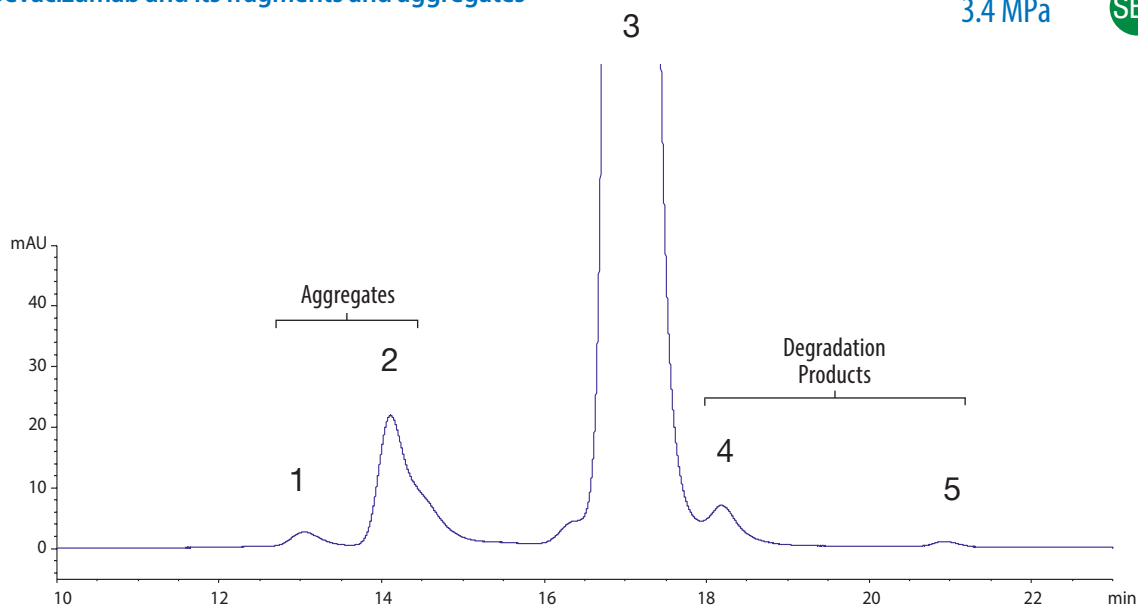

Column: YMC-SEC MAB (3  $\mu$ m, 25 nm) 300 x 4.6 mm ID  
 Part No.: DLM25S03-3046WT  
 Eluent: 0.1 M phosphate buffer (pH = 7) cont. 0.2 M NaCl  
 Flow rate: 0.165 mL/min  
 Temperature: 25 °C  
 Detection: UV at 280 nm  
 Cell path: 10 mm  
 Injection: 10  $\mu$ L (5 mg/mL)  
 Sample: Bevacizumab (Avastin®)

## Analysis of digested antibody

- 1. Antibody monomer
- 2. Fab dimer
- 3. FC
- 4. Fab

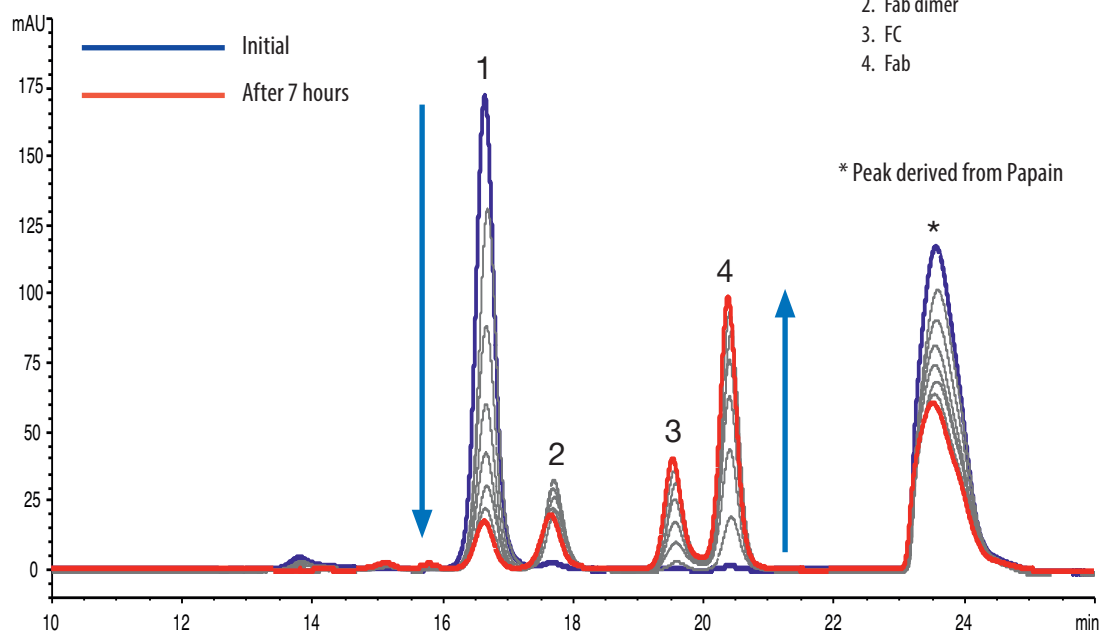

Column: YMC-SEC MAB (3  $\mu$ m, 25 nm) 300 x 4.6 mm ID  
 Part No.: DLM25S03-3046WT  
 Eluent: 0.1 M phosphate buffer (pH = 7) cont. 0.2 M NaCl  
 Flow rate: 0.165 mL/min

Temperature: 25 °C  
 Detection: UV at 280 nm  
 Injection: 2  $\mu$ L (3 mg/mL)  
 Sample: Humanised monoclonal IgG1 + Papain



## Immunglobulin digest

SEC

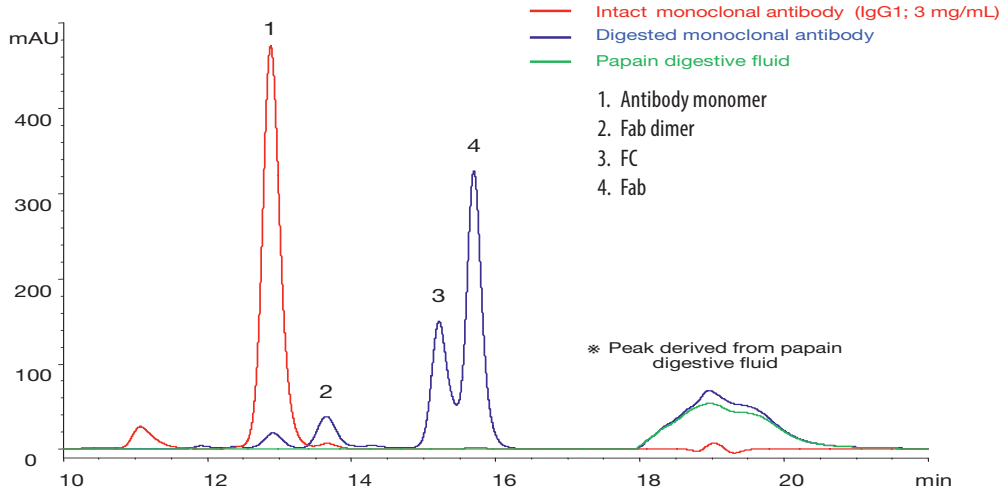

Column: YMC-Pack Diol-200 (2 µm, 20 nm) 300 x 4.6 mm ID  
 Part No.: DL20S02-3046PTH  
 Eluent: 0.1 M KH<sub>2</sub>PO<sub>4</sub>-K<sub>2</sub>HPO<sub>4</sub> (pH 7.0) containing 0.2 M NaCl  
 Flow rate: 0.2 mL/min

Temperature: ambient  
 Detection: UV at 280 nm  
 Sample: IgG1 (3 mg/mL)

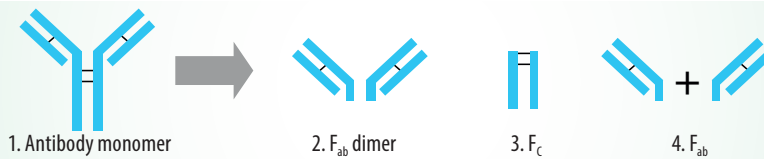

## LC/MS compatible analysis of monoclonal antibody fragments

RP

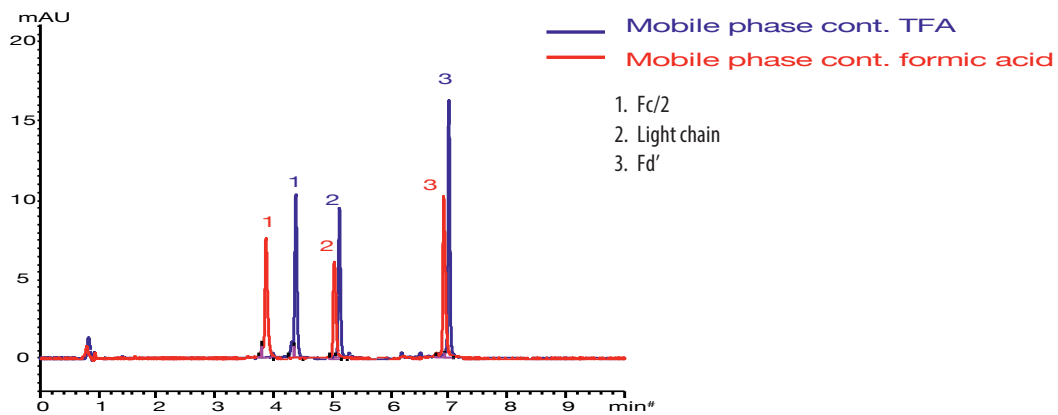

Column: YMC-Triart Bio C4 (1.9 µm, 30 nm) 150 x 2.1 mm ID  
 Part No.: TB30SP9-15Q1PT  
 Eluent <TFA>: A) water/TFA (100/0.1)  
                   B) acetonitrile/TFA (100/0.1)  
 Gradient <TFA>: 25-50%B (0-10 min), 90%B (10-12.5 min)  
 Eluent <Formic acid>: A) water/formic acid (100/0.1)  
                               B) acetonitrile/formic acid (100/0.1)

Gradient <Formic acid>: 20-45%B (0-10 min), 90%B (10-12.5 min)  
 Flow rate: 0.4 mL/min  
 Temperature: 80°C  
 Injection: 4 µL (0.25 mg/mL)  
 Detection: UV at 280 nm  
 Sample: mAb Subunit Standard (Waters Corp.)

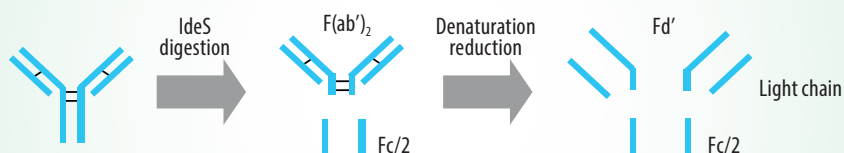

# BioLC applications – Antibodies

## Adalimumab (Humira®, MW: ca. 148 kDa)

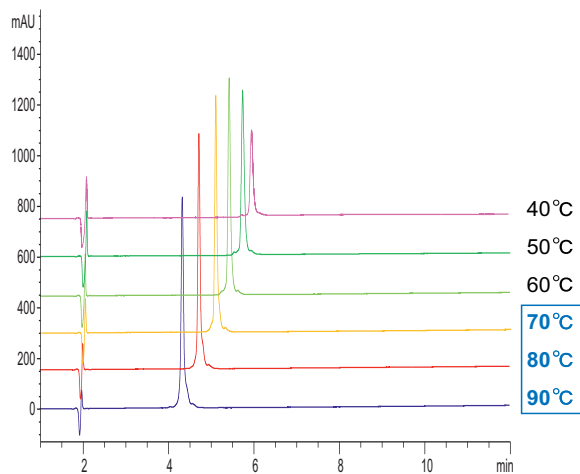

## Bevacizumab (Avastin®, MW: ca. 148 kDa)

RP

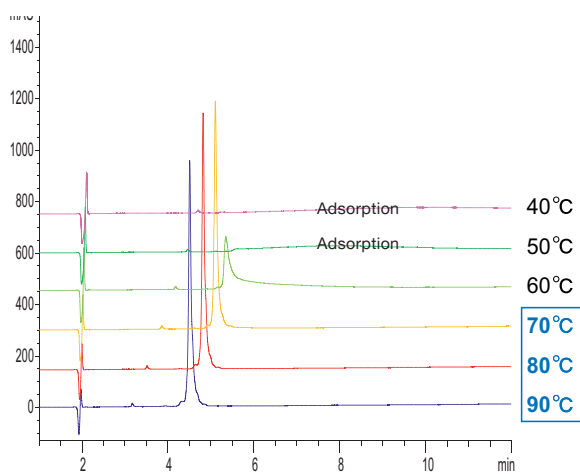

Column: YMC-Triart Bio C4 (3 µm, 30 nm) 150 x 3.0 mm ID  
 Part No.: TB30S03-1503PTH  
 Eluent: A) water/TFA (100/0.1)  
 B) acetonitrile/TFA (100/0.1)  
 Gradient: 30–60%B (0–15 min), 90%B (15–30min)  
 Flow rate: 0.4 mL/min  
 Detection: UV at 220 nm  
 Injection: 4 µL  
 Sample: Adalimumab (0.5 mg/mL) or Bevacizumab (0.5 mg/mL)

## Analysis of different monoclonal antibodies

RP

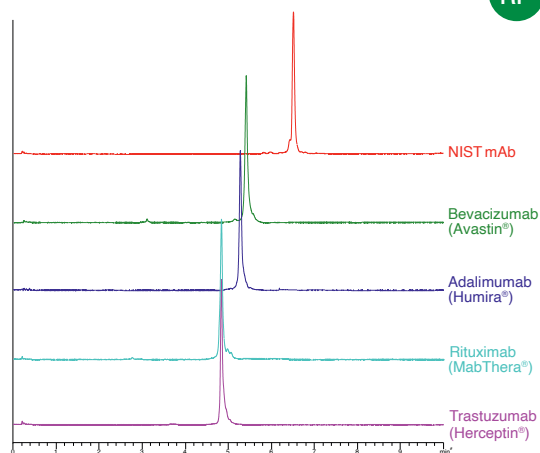

Column: YMC-Triart Bio C4 (1.9 µm, 30 nm) 50 x 2.1 mm ID  
 Part No.: TB30SP9-05Q1PT  
 Eluent: A) water/TFA (100/0.1)  
 B) acetonitrile/TFA (100/0.1)  
 Gradient: 25–45%B (0–10 min)  
 Flow rate: 0.4 mL/min  
 Temperature: 80 °C  
 Detection: UV at 280 nm (0.13s, 40Hz)  
 Injection: 2 µL (0.5 mg/mL)

## Analysis of challenging monoclonal antibodies

RP

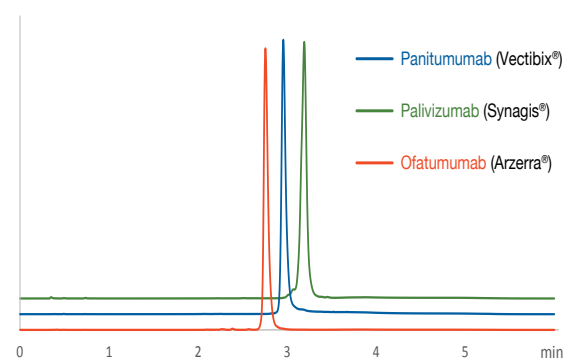

Column: YMC-Triart Bio C4 (1.9 µm, 30 nm) 50 x 2.1 mm ID  
 Part No.: TB30SP9-05Q1PT  
 Eluent: A) 0.1 % TFA in water  
 B) 0.1 % TFA in acetonitrile  
 Gradient: 25–50%B (0–4 min)  
 Flow rate: 0.4 mL/min  
 Temperature: 90 °C  
 Detection: Fluorescence: ex 280nm, em 350nm  
 Injection: 0.5 µL

By courtesy of University of Geneva, Institute of Pharmaceutical Sciences of Western Switzerland (ISPSO)

## Native online SCX-MS analysis of monoclonal antibodies



[TIC, native NISTmAb]

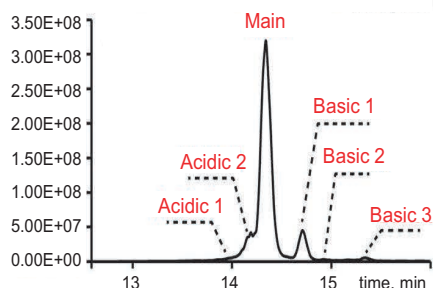

[Raw mass spectrum]

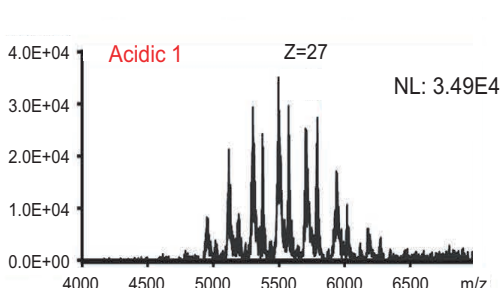

[Deconvoluted mass spectra]

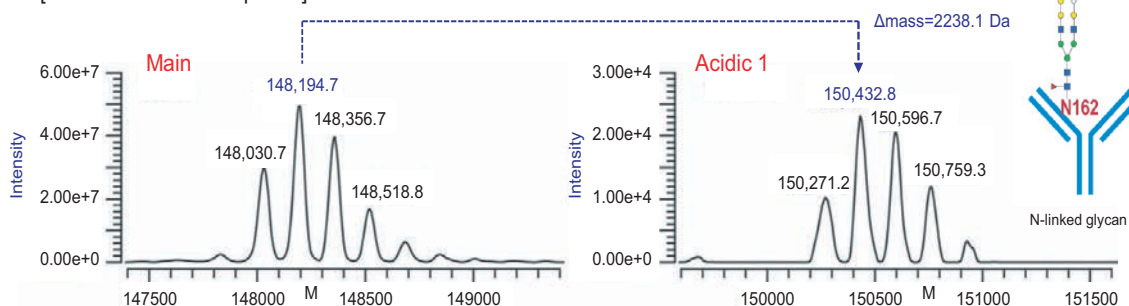

Column: BioPro IEX SF (5 μm) 100 x 4.6 mm ID  
 Part No.: SF00S05-1046WP  
 Eluent: A) 20 mM CH<sub>3</sub>COONH<sub>4</sub>-CH<sub>3</sub>COOH (pH 5.6)  
 B) 140 mM CH<sub>3</sub>COONH<sub>4</sub>-10 mM NH<sub>4</sub>HCO<sub>3</sub> (pH 7.4)  
 Gradient: 0%B (0–2 min), 0–100%B (2–18 min), 100%B (18–22 min)  
 Flow rate: 0.4 mL/min  
 (To enable online simultaneous UV and MS detection,  
 a post-column analytical splitter (~400:1 ratio) was connected)

Temperature: 45 °C  
 Detection: nanospray ionization-mass spectrometry (NSI-MS)  
 Load: 50 μg  
 System: LC) ACQUITY UPLC I-Class system (Waters)  
 MS) Exactive™ Plus EMR mass spectrometer  
 (Thermo Fisher Scientific)

Courtesy of S. Wang, Regeneron Pharmaceuticals Inc.

Reference: Y. Yan, A. P. Liu, S. Wang, T. J. Daly and N. Li, Ultrasensitive Characterization of Charge Heterogeneity of Therapeutic Monoclonal Antibodies, Anal. Chem., 2018, 90, 13013-20.

## Different production batches of IgG1

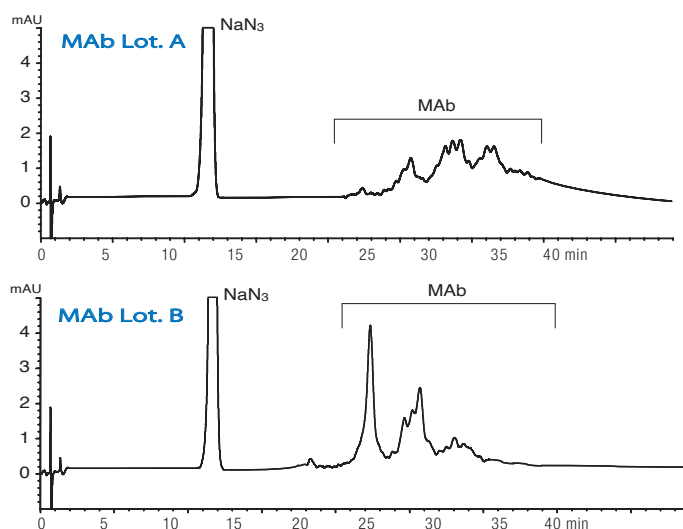

Column: BioPro IEX QF (5 μm) 100 x 4.6 mm ID  
 Part No.: QF00S05-1046WP  
 Eluent: A) 20 mM Tris-HCl (pH 8.1)  
 B) 20 mM Tris-HCl (pH 8.1) containing 0.5 M NaCl  
 Gradient: 10–25%B (0–60 min)  
 Flow rate: 1.0 mL/min (360 cm/hr)

Temperature: 25 °C  
 Detection: UV at 220 nm  
 Injection: 14 μL (0.1 mg/mL)  
 Sample: Mouse monoclonal IgG1 anti-human IgG4  
 (Purified by DEAE chromatography, containing NaN<sub>3</sub>)

# BioLC applications – Antibodies

## Analysis of oxidised monoclonal antibodies

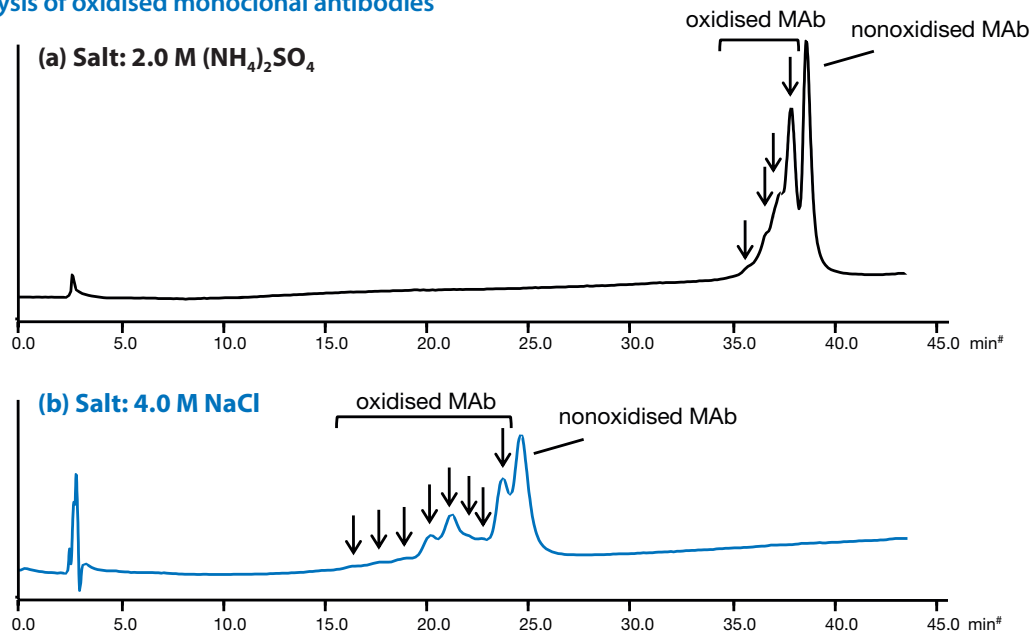

HIC

Column:	BioPro HIC BF (4 μm) 100 x 4.6 mm ID	Flow rate:	0.3 mL/min
Part No.:	BHB00S04-1046WT	Temperature:	25 °C
Eluent:	A) 100 mM NaH <sub>2</sub> PO <sub>4</sub> -Na <sub>2</sub> HPO <sub>4</sub> (pH 7.0) containing salt	Detection:	UV at 280 nm
Gradient:	B) 100mM NaH <sub>2</sub> PO <sub>4</sub> -Na <sub>2</sub> HPO <sub>4</sub> (pH 7.0)	Injection:	5 μL (1.0 mg/mL)
	40–80%B (0–40 min), 80%B (40–45 min)	Sample:	oxidised NISTmAb

## HIC analysis of different monoclonal antibodies using isopropanol as modifier

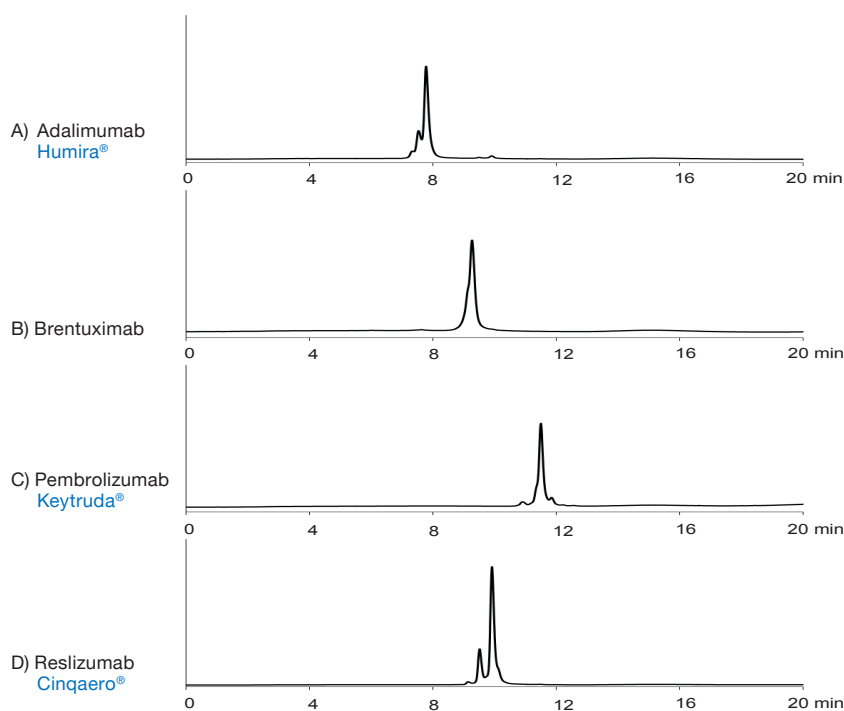

HIC

Column:	BioPro HIC BF (4 μm) 100 x 4.6 mm ID	Temperature:	20 °C
Part No.:	BHB00S04-1046WT	Detection:	Fluorescence: ex 280nm, em 360nm
Eluent:	A) 20 mM NaH <sub>2</sub> PO <sub>4</sub> -Na <sub>2</sub> HPO <sub>4</sub> (pH 7.4) containing 1.5 M (NH <sub>4</sub> ) <sub>2</sub> SO <sub>4</sub>	Injection:	3 μL (2 mg/mL)
Gradient:	B) 20 mM NaH <sub>2</sub> PO <sub>4</sub> -Na <sub>2</sub> HPO <sub>4</sub> (pH 7.4) / 2-propanol (85/15)		
Flow rate:	0–100%B (0–20 min)		
	1.0 mL/min		

By courtesy of University of Geneva, Institute of Pharmaceutical Sciences of Western Switzerland (ISPSO)

# BioLC applications – Antibody-Drug-Conjugates

## High throughput DAR determination by shortening analysis time

HIC

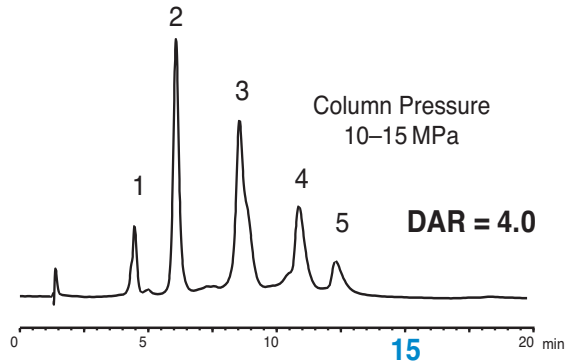

1. DAR 0
2. DAR 2
3. DAR 4
4. DAR 6
5. DAR 8

Flow rate  
0.5 mL/min

**2.5 x faster**

Flow rate  
**1.2 mL/min**

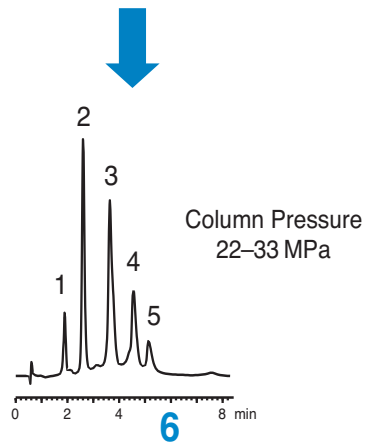

Column: BioPro HIC HT (2.3  $\mu$ m) 100 x 4.6 mm ID  
 Part No.: BHH00SQ3-1046PTH  
 Eluent: A) 20 mM  $\text{NaH}_2\text{PO}_4$ - $\text{Na}_2\text{HPO}_4$  (pH 7.0) containing 1.0 M  $(\text{NH}_4)_2\text{SO}_4$   
 B) 20 mM  $\text{NaH}_2\text{PO}_4$ - $\text{Na}_2\text{HPO}_4$  (pH 7.0)/2-propanol (85/15)  
 Gradient: 0–100%B (0–15 min), 100%B (15–20 min)  
 0–100%B (0–6.25 min), 100%B (6.25–8.3 min)  
 Temperature: 25  $^\circ\text{C}$   
 Detection: UV at 280 nm  
 Injection: 10  $\mu\text{L}$   
 Sample: Brentuximab vedotin (Adcetris<sup>®</sup>) (2.5 mg/mL)

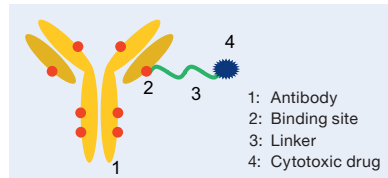

# BioLC applications – Antibody-Drug-Conjugates

## Native online HIC-MS analysis of cys-linked ADCs

HIC

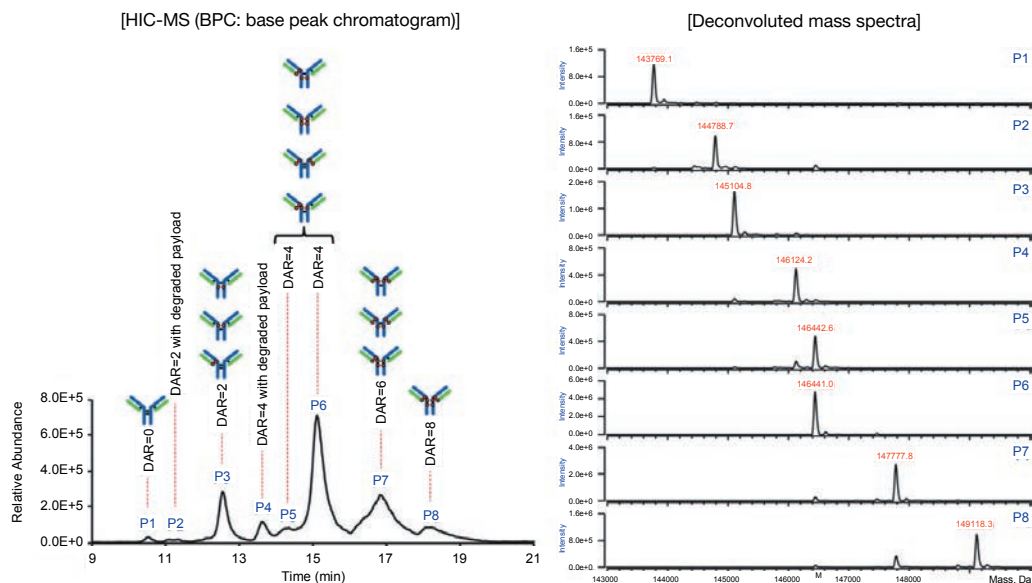

Column: BioPro HIC BF (4  $\mu$ m) 100 x 4.6 mm ID  
 Part number: BHB00S04-1046WT  
 Eluent: A) 3 M ammonium acetate in water  
 B) 2-propanol/water (30/70)  
 Gradient: 10%B (0–2 min), 10–97%B (2–18 min), 97%B (18–22 min)  
 Flow rate: 0.3 mL/min  
 Temperature: ambient  
 Detection: UV at 280 nm, NSI-MS

Injection: 10  $\mu$ g  
 Sample: SigmaMAB ADC-mimic  
 Setup: Post-column makeup flow:  
 100% water at 1.5 mL/min (reducing salt conc. 6-fold)  
 Splitter to reduce the flow rate to 1–5  $\mu$ L/min

Courtesy by S. Wang, Regeneron Pharmaceuticals Inc.

Reference: Y. Yan, T. Xing, S. Wang, T. J. Daly, N. Li, Online coupling of analytical hydrophobic interaction chromatography with native mass spectrometry for the characterization of monoclonal antibodies and related products, *J. Pharm. Biomed. Anal.* 186 (2020) 113313.

## Separation of Brentuximab vedotin from its aggregates and fragments

SEC

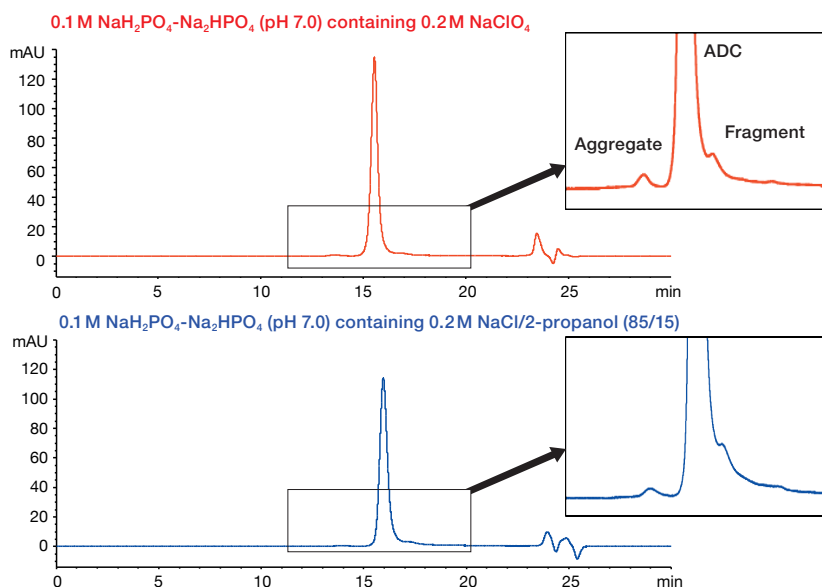

Column: YMC-SEC MAB (3  $\mu$ m, 25 nm) 300 x 4.6 mm ID  
 Part No.: DLM25S03-3046WT  
 Eluent: 0.1 M phosphate buffer (pH = 7) cont. 0.2 M NaClO<sub>4</sub>  
 0.1 M phosphate buffer (pH = 7) cont. 0.2 M NaCl/2-propanol (85/15)  
 Flow rate: 0.165 mL/min

Temperature: 25 °C  
 Detection: UV at 280 nm  
 Injection: 4  $\mu$ L (2.5 mg/mL)  
 Sample: Brentuximab vedotin (Adcetris®) for injection

Courtesy of Prof. S. Manabe, Hoshi University, Tokyo/Tohoku University, Sendai Japan.

Reference: H. Wang, M. S. Levi, A. V. Del Grosso, W. M. McCormick, L. Bhattacharyya, An improved size exclusion-HPLC method for molecular size distribution analysis of immunoglobulin G using sodium perchlorate in the eluent, *J. Pharm. Biomed. Anal.*, 138 (2017) 330-343.

## Proteins (MW 5,700 ~ 66,000)

RP

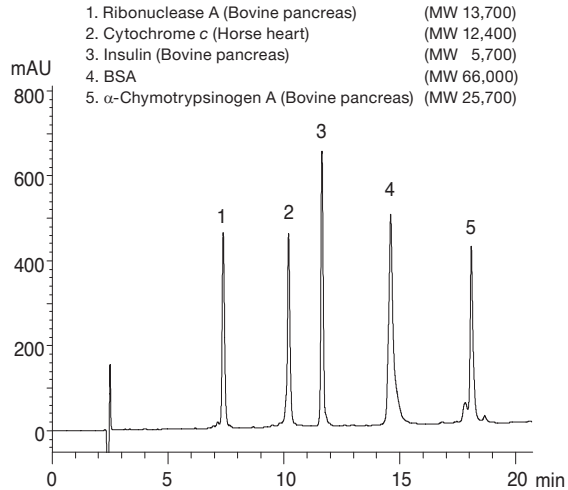

Column: YMC-Triart Bio C4 (5  $\mu$ m, 30 nm) 150 x 3.0 mm ID  
 Part No.: TB30S03-1503PTH  
 Eluent: A) water/TFA (100/0.1)  
 B) acetonitrile/TFA (100/0.1)  
 Gradient: 20-60%B (0-27 min), 90%B (27-35 min)  
 Flow rate: 0.4 mL/min  
 Temperature: 70 °C  
 Detection: UV at 220 nm  
 Injection: 10  $\mu$ L (0.25-0.50 mg/mL)

## Proteins (MW 14,300 ~ 77,000)

RP

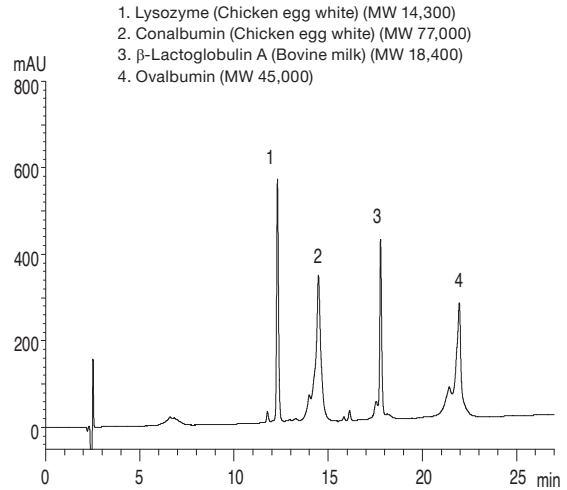

Column: YMC-Triart Bio C4 (5  $\mu$ m, 30 nm) 150 x 3.0 mm ID  
 Part No.: TB30S03-1503PTH  
 Eluent: A) water/TFA (100/0.1)  
 B) acetonitrile/TFA (100/0.1)  
 Gradient: 20-60%B (0-27 min), 90%B (27-35 min)  
 Flow rate: 0.4 mL/min  
 Temperature: 70 °C  
 Detection: UV at 220 nm  
 Injection: 10  $\mu$ L (0.25 - 0.50 mg/mL)

## Proteins in human serum

SEC

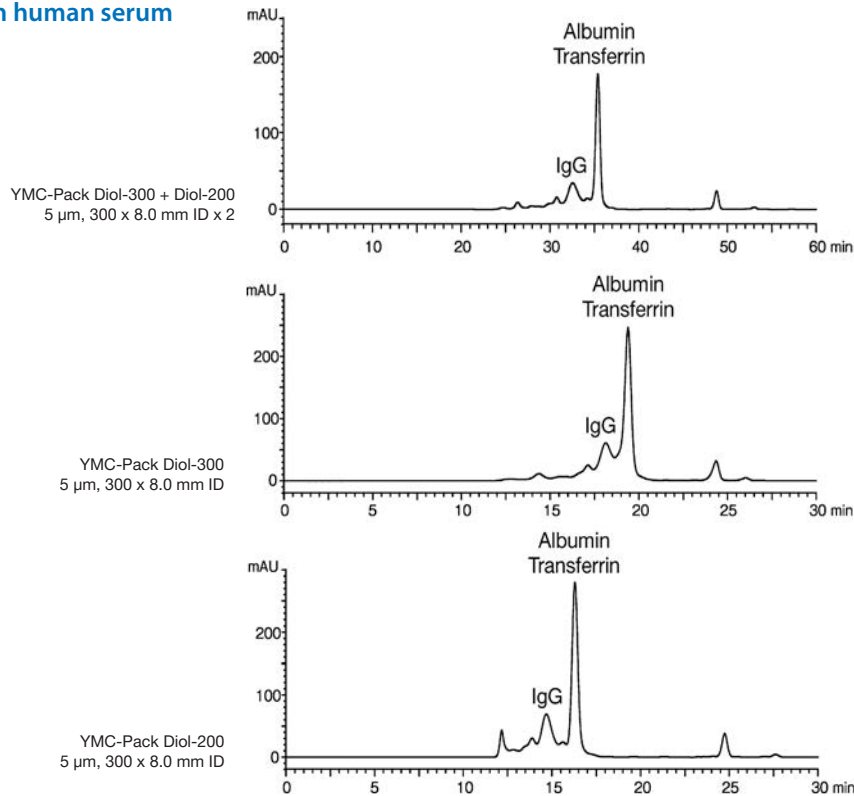

Eluent: 0.1 M  $\text{KH}_2\text{PO}_4$ - $\text{K}_2\text{HPO}_4$  (pH 7.0) containing 0.2 M NaCl  
 Part Nos.: DL30S05-3008WT + DL20S05-3008WT  
 Flow rate: 0.5 mL/min  
 Temperature: ambient (25 °C)

Detection: UV at 280 nm  
 Injection: 20  $\mu$ L  
 Sample: Human serum (100  $\mu$ L/mL)

# BioLC applications – Proteins

## Separation of proteins in human serum

IEX

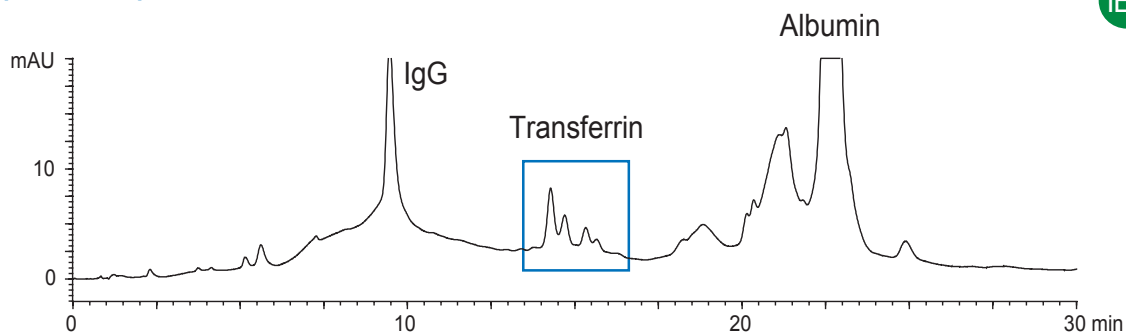

Column:	BioPro IEX QA (5 µm) 50 x 4.6 mm ID	Flow rate:	0.5 mL/min
Part No.:	QAA0S05-0546WP	Temperature:	25 °C
Eluent:	A) 20 mM Tris-HCl (pH 8.6)	Detection:	UV at 280 nm
	B) 20 mM Tris-HCl (pH 8.6) containing 0.5 M NaCl	Injection:	20 µL
Gradient:	0–30%B (0–15 min), 30–100%B (15–30 min)	Sample:	Human serum (100 µL/mL)

## Plasma constituents

SEC

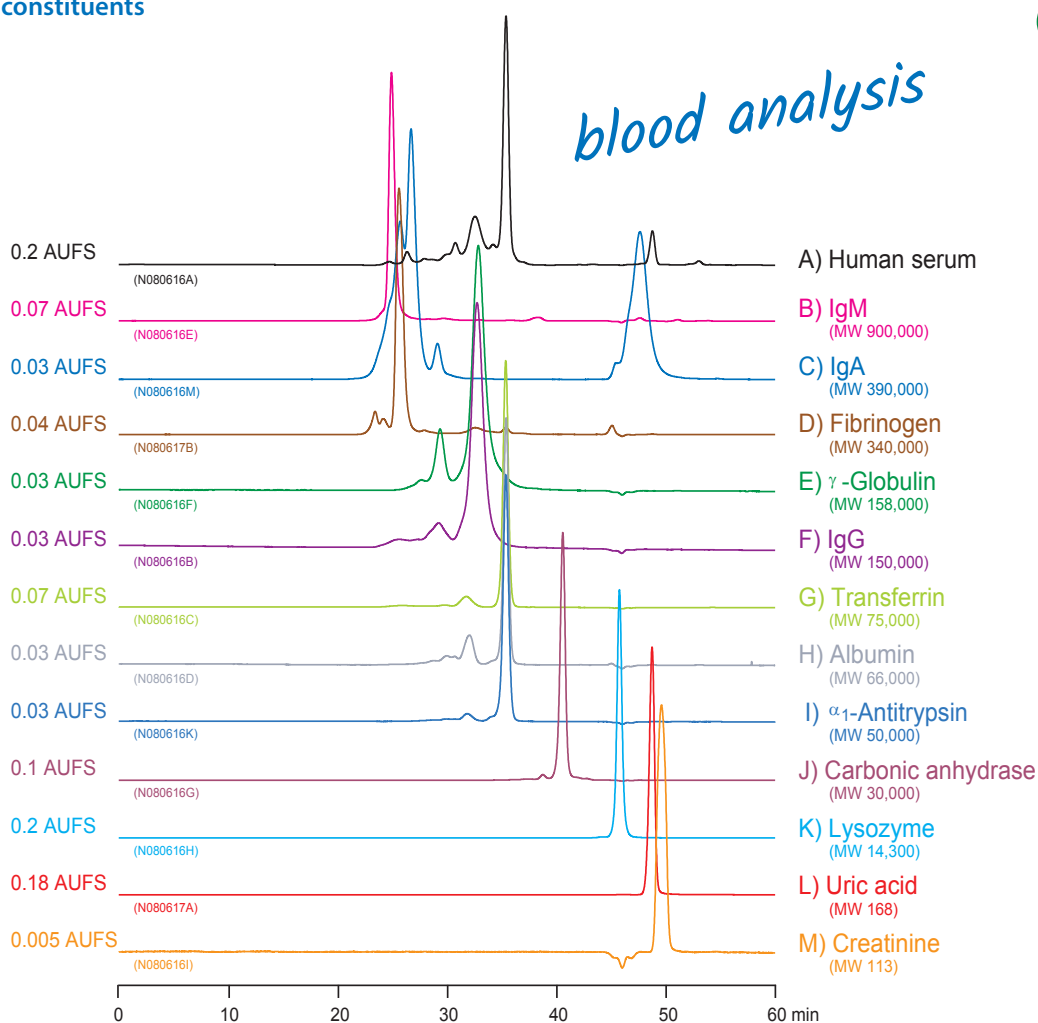

Columns:	YMC-Pack Diol-300 + Diol-200 (5 µm) 300 x 8.0 mm ID x 2	Temperature:	ambient (25 °C)
Part Nos.:	DL30S05-3008WT + DL20S05-3008WT	Detection:	UV at 280 nm
Eluent:	0.1 M KH <sub>2</sub> PO <sub>4</sub> -K <sub>2</sub> HPO <sub>4</sub> (pH 7.0) containing 0.2 M NaCl	Injection:	20 µL (L: 1 µL)
Flow rate:	0.5 mL/min	Sample:	A) 100 µL/mL; B-M) 1.0 mg/mL



## Peptides covering different MW

RP

1. Oxytocin (MW: 1,007)
2. Met-Enkephalin (MW: 574)
3. Leu-Enkephalin (MW: 556)
4. Neurotensin (MW: 1,673)
5.  $\gamma$ -Endorphin (MW: 1,859)
6.  $\beta$ -Endorphin (MW: 3,465)

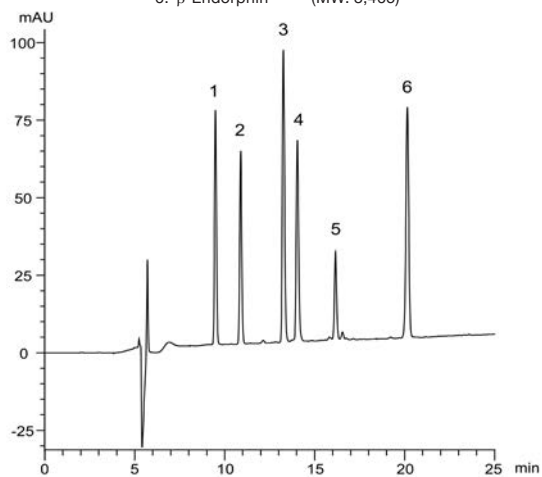

Column: YMC-Triart C18 (5  $\mu$ m, 12 nm) 150 x 2.0 mm ID  
 Part No.: TA12S05-1502WT  
 Eluent: A) water/TFA (100/0.1)  
 B) acetonitrile / TFA (100/0.1)  
 Gradient: 20%–45%B (0–25 min)  
 Flow rate: 0.2 mL/min  
 Temperature: 37 °C  
 Detection: UV at 220 nm  
 Injection: 2  $\mu$ L (0.075  $\approx$  0.25 mg/mL)

## Antimicrobial peptides

RP

1.  $\alpha$ -Defensin-1 (human) (MW: 3,442)
2.  $\alpha$ -Defensin-2 (human) (MW: 3,371)
3.  $\alpha$ -Defensin-3 (human) (MW: 3,486)

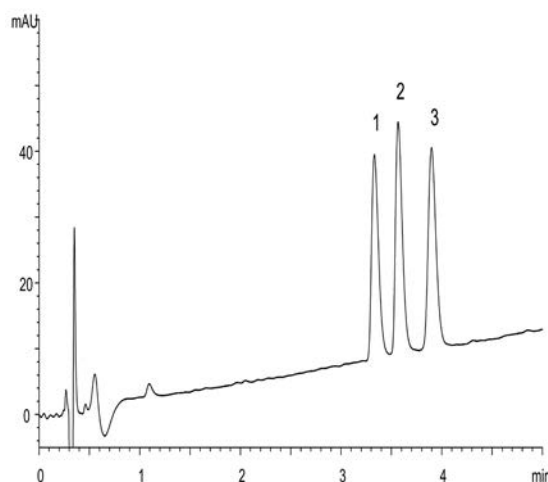

Column: YMC-Triart C18 (1.9  $\mu$ m, 12 nm) 50 x 2.0 mm ID  
 Part No.: TA12SP9-0502PT  
 Eluent: A) water/formic acid (100/0.1)  
 B) 2-propanol/acetonitrile/formic acid (50/50/0.08)  
 Gradient: 10%–25%B (0–10 min)  
 Flow rate: 0.4 mL/min  
 Temperature: 70 °C  
 Detection: UV at 220 nm  
 Injection: 1  $\mu$ L (50  $\mu$ g/mL)

## Amyloid $\beta$ -peptides

RP

1. Amyloid  $\beta$  (1-38) (Human) (MW 4,132)
2. Amyloid  $\beta$  (1-40) (Human) (MW 4,330)
3. Amyloid  $\beta$  (1-42) (Human) (MW 4,514)
4. Amyloid  $\beta$  (1-43) (Human) (MW 4,615)

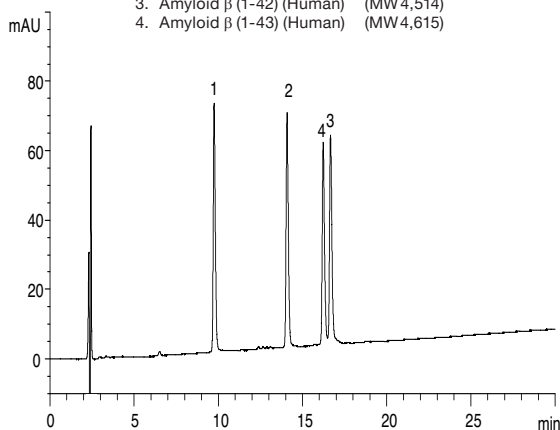

Amyloid  $\beta$  (1-43): Asp-Ala-Glu-Phe-Arg-His-Asp-Ser-Gly-Tyr-Glu-Val-His-His-Gln-Lys-Leu-Val-Phe-Phe-Ala-Glu-Asp-Val-Gly-Ser-Asn-Lys-Gly-Ala-Ile-Ile-Gly-Leu-Met-Val-Gly-Gly-Val-Val-Ile-Ala-Thr

Column: YMC-Triart Bio C4 (3  $\mu$ m, 30 nm) 150 x 3.0 mm ID  
 Part No.: TB30S03-1503PTH  
 Eluent: A) water/TFA (100/0.1)  
 B) acetonitrile/TFA (100/0.1)  
 Gradient: 25–40%B (0–30 min), 90%B (30–40 min)  
 Flow rate: 0.4 mL/min  
 Temperature: 70 °C  
 Detection: UV at 220 nm  
 Injection: 4  $\mu$ L (each 0.1 mg/mL)

## Peptides

RP

1. BAM-12P (MW 1,425)
2. [D-Ala<sup>2</sup>, Met<sup>5</sup>]-Enkephalinamide (MW 587)
3. Met-Enkephalin (MW 574)
4. [D-Ala<sup>2</sup>, Met<sup>5</sup>]-Enkephalin (MW 588)
5.  $\alpha$ -Endorphin (MW 1,746)
6.  $\gamma$ -Endorphin (MW 1,859)
7.  $\beta$ -Endorphin (MW 3,465)

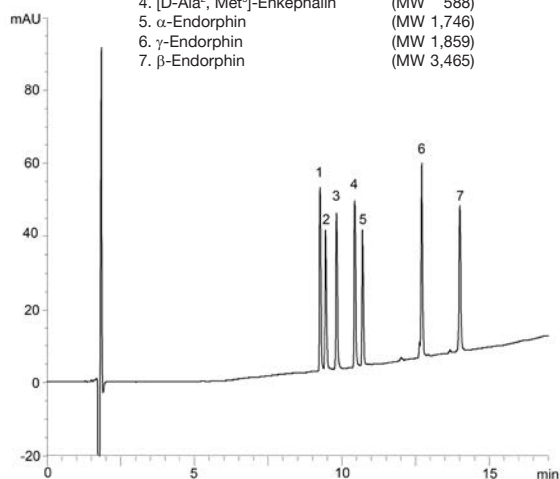

Column: Meteoric Core C18 BIO (2.7  $\mu$ m, 16 nm) 150 x 2.1 mm ID  
 Part No.: CAW16SQ7-15Q1PT  
 Eluent: A) water/TFA (100/0.1)  
 B) acetonitrile/TFA (100/0.1)  
 Gradient: 15–55%B (0–15 min), 55%B (15–17 min)  
 Flow rate: 0.2 mL/min  
 Temperature: 40 °C  
 Detection: UV at 220 nm  
 Injection: 2  $\mu$ L (0.02–0.5 mg/mL)  
 Pressure: 14.9–16.1 MPa (2,160–2,330 psi)

# BioLC applications – Peptide Mapping / Oligonucleotides

## Tryptic digest of Hemoglobin

RP

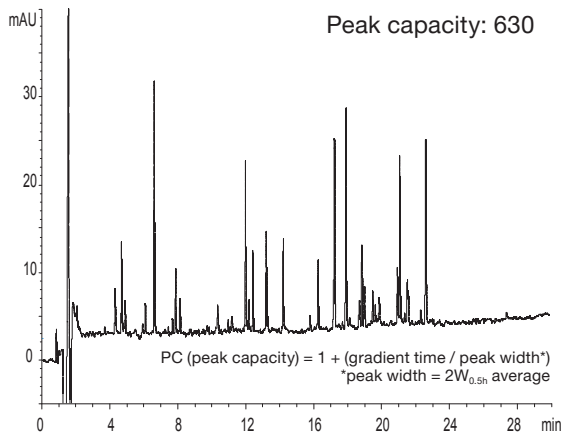

Column: YMC-Triart C18 (1.9  $\mu\text{m}$ , 12 nm) 200 x 2.0 mm ID  
 (Two coupled 100 x 2.0 mm ID)  
 Part No.: TA12SP9-1002PT (2x)  
 Eluent: A) water/TFA (100/0.1)  
 B) acetonitrile/TFA (100/0.08)  
 Gradient: 5–40%B (0–30 min)  
 Flow rate: 0.4 mL/min  
 Temperature: 70 °C  
 Detection: UV at 220 nm  
 Injection: 20  $\mu\text{L}$   
 Sample: Tryptic digest of Bovine Hemoglobin (2.5 nmol/mL)  
 Pressure: 58.1–61.6 MPa (8,430–8,930 psi)

## Peptide mapping of tryptic digests of BSA with highest sensitivity

IEX

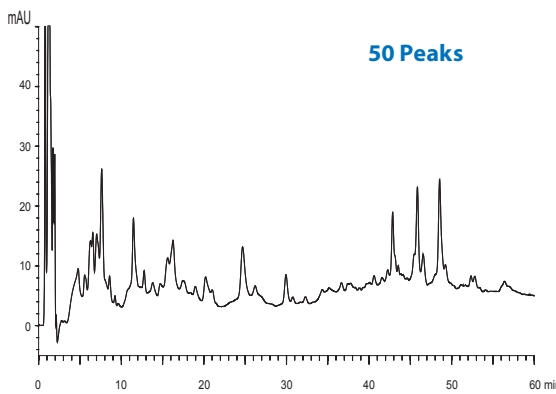

Column: BioPro IEX QA (5  $\mu\text{m}$ ) 50 x 4.6 mm ID  
 Part No.: QAA0S05-0546WP  
 Eluent: A) 20 mM Tris-HCl (pH 8.6)  
 B) 20 mM Tris-HCl (pH 8.6) containing 0.5 M NaCl  
 Gradient: 0–15%B (0–30 min), 15–60%B (30–60 min)  
 Flow rate: 0.5 mL/min  
 Temperature: 25 °C  
 Detection: UV at 220 nm  
 Injection: 20  $\mu\text{L}$   
 Sample: Tryptic digest of BSA

## Separation of synthetic oligonucleotides (single-strand DNA)

IEX

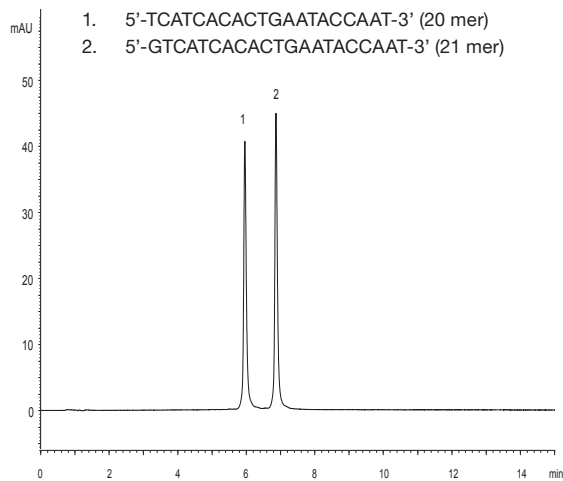

Column: BioPro IEX QF (5  $\mu\text{m}$ ) 100 x 4.6 mm ID  
 Part No.: QF00S05-1046WP  
 Eluent: A) 10 mM NaOH  
 B) 10 mM NaOH containing 1.0 M NaClO<sub>4</sub>  
 Gradient: 25–55%B (0–15 min), 100%B (15–20 min)  
 Flow rate: 1.0 mL/min  
 Temperature: 25 °C  
 Detection: UV at 260 nm  
 Injection: 4  $\mu\text{L}$  (5 nmol/L)

## Oligonucleotides d(T)2-20 method transfer from HPLC to UHPLC

RP

### Conventional LC method

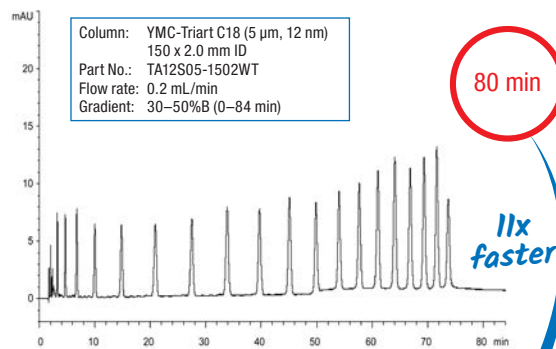

### UHPLC method

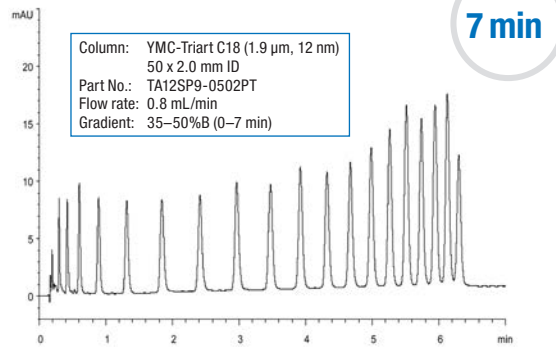

Eluent: A) 10 mM di-n-butylamine-acetic acid (pH 6.0)  
 B) methanol  
 Temperature: 37 °C  
 Detection: UV at 269 nm  
 Injection: 1  $\mu\text{L}$  (5 nmol/mL)

## LC-MS analysis of synthetic 27-30 mer oligonucleotides

RP

Sample: Primer of DNA sequencing  
5'-CCGCTCGAGCTAAAAAAGCCTGTGTTACC-3' (30 mer)

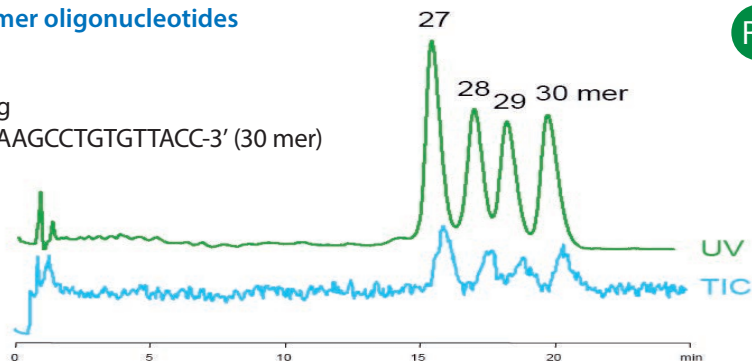

Column: Hydrosphere C18 (3  $\mu$ m) 50 x 2.0 mm ID  
Part No.: HS12S03-0502WT  
Eluent: A) 10 mM DBAA (pH 6.0)  
B) Mobile phase A / acetonitrile (50/50)  
Gradient: 58%–62%B (0–20 min), 62%B (20–25 min)

Flow rate: 0.2 mL/min  
Temperature: 35 °C  
Detection: UV at 269 nm and ESI negative-mode  
Injection: 1  $\mu$ L (10 pmol/component)

## LC/MS analysis of miRNA

RP

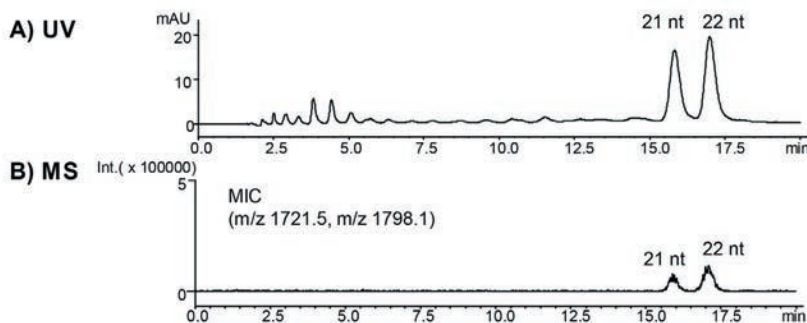

Courtesy of M. Yamada, SHIMADZU CORPORATION

5'-pUGG AGU GUG ACA AUG GUG UUG-3' (21 nt, MW 6,890.1)  
5'-pUGG AGU GUG ACA AUG GUG UUG U-3' (22 nt, MW 7,196.3)

Column: YMC-Triart C18 (3  $\mu$ m, 12 nm) 150 x 2.0 mm ID  
Part No.: TA12S03-1502WT  
Eluent: A) 10 mM di-n-butylamine-acetic acid (pH 7.5)  
B) 10 mM di-n-butylamine-acetic acid (pH 7.5)/acetonitrile (50/50)  
Gradient: 62–72%B (0–20 min)  
Flow rate: 0.2 mL/min

Temperature: 30 °C  
Detection: A) UV at 260 nm  
B) ESI-negative mode  
Injection: 4  $\mu$ L (5 nmol/mL)  
System: LC) Shimadzu Prominence  
MS) Shimadzu LCMS2020

## Challenging phosphorothioate oligonucleotides

RP

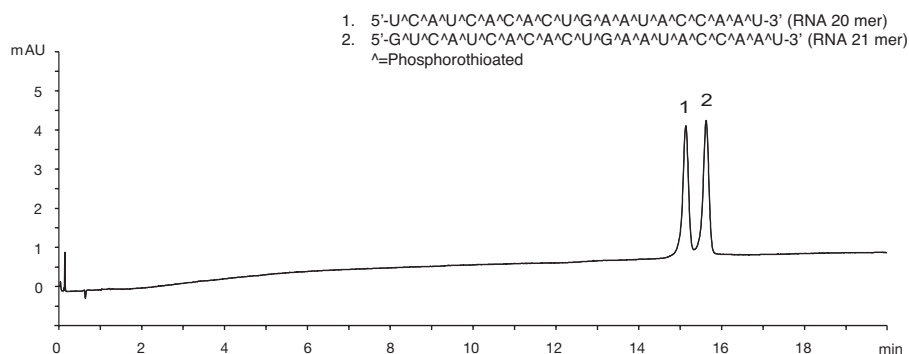

- 5'-U<sup>^</sup>A<sup>^</sup>C<sup>^</sup>A<sup>^</sup>A<sup>^</sup>U<sup>^</sup>C<sup>^</sup>A<sup>^</sup>C<sup>^</sup>A<sup>^</sup>C<sup>^</sup>A<sup>^</sup>U<sup>^</sup>G<sup>^</sup>A<sup>^</sup>A<sup>^</sup>U<sup>^</sup>A<sup>^</sup>C<sup>^</sup>A<sup>^</sup>A<sup>^</sup>U<sup>^</sup>-3' (RNA 20 mer)
  - 5'-G<sup>^</sup>U<sup>^</sup>C<sup>^</sup>A<sup>^</sup>A<sup>^</sup>U<sup>^</sup>C<sup>^</sup>A<sup>^</sup>C<sup>^</sup>A<sup>^</sup>C<sup>^</sup>A<sup>^</sup>U<sup>^</sup>G<sup>^</sup>A<sup>^</sup>A<sup>^</sup>U<sup>^</sup>A<sup>^</sup>C<sup>^</sup>A<sup>^</sup>A<sup>^</sup>U<sup>^</sup>-3' (RNA 21 mer)
- <sup>^</sup>=Phosphorothioated

Column: YMC-Triart C8 **metal-free** (1.9  $\mu$ m, 12 nm) 100 x 2.1 mm ID  
Part No.: TO12SP9-10Q1PTP  
Eluent: A) 15mM triethylamine-400 mM HFIP\*  
B) methanol  
Gradient: 10–20%B (0–20 min)

Flow rate: 0.42 mL/min  
Temperature: 70 °C  
Detection: UV at 260 nm  
Injection: 1  $\mu$ L (each 1.25 nmol/mL)

\*1,1,1,3,3,3-hexafluoro-2-propanol

# BioLC applications – Oligonucleotides / Plasmids

## LC-HRMS analysis of the antisense oligonucleotide Mipomersen (Kynamro®)

RP

Total ion chromatogram

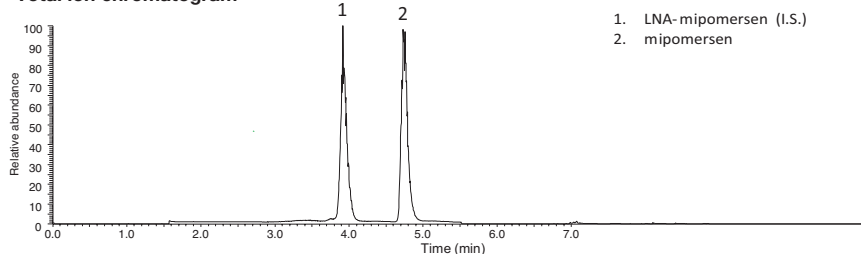

1. LNA- mipomersen (I.S.)
2. mipomersen

Mass spectrum of mipomersen

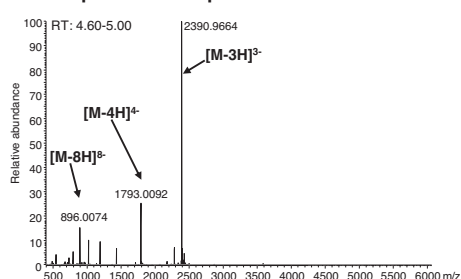

Mass spectrum of LNA-mipomersen

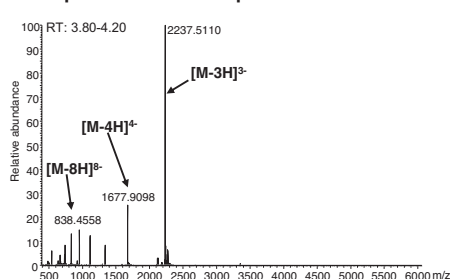

Column: YMC-Triart C8 metal-free (1.9 μm, 12nm)<sup>1</sup> 100 x 2.1 mm ID  
 Part No.: TO12SP9-10Q1PTP  
 Eluent: A) water/triethylamine/HFIP<sup>2</sup> (100/0.4/2; triethylamine 28.0mM, HFIP 135.8mM)  
 B) methanol/triethylamine/HFIP (100/0.4/2)  
 Gradient: [Sample separation step] 10–40%B (0–5.0 min)

[Column wash steps] 40–70%B (5.0–5.1 min), 70%B (5.1–7.0 min), 70–10%B (7.0–7.1 min), 10%B (7.1–8.0 min), 10–90%B (8.0–8.1 min), 90%B (8.1–9.0 min), 90–10%B (9.0–9.1 min), 10%B (9.1–10.0 min), 10–90%B (10.0–10.1 min), 90%B (10.1–11.0 min), 90–10%B (11.0–11.1 min)  
 Flow rate: 0.3mL/min  
 Temperature: 50°C  
 Injection: 10 μL (1000ng/mL)  
 System : LC) Vanquish Binary Pump H system  
 HRMS) Orbitrap HRMS Q Exactive Plus

\*1 Prewash the column prior to the first use with water/methanol/phosphoric acid (70/30/0.1) for 1 hour

\*2 1,1,1,3,3,3-hexafluoro-2-propanol

Reference: Y. Sun et al, Development of a bioanalytical method for an antisense therapeutic using high-resolution mass spectrometry, Bioanalysis, 2020 NOV 26, doi: 10.4155/bio-2020-0225.

## Plasmid pBR322 restriction and pBR322 Hae III restriction fragment

SEC IEX

1. Plasmid pBR322 (4,361 bp)
2. Plasmid pBR322 Hae III digest (8-587 bp)

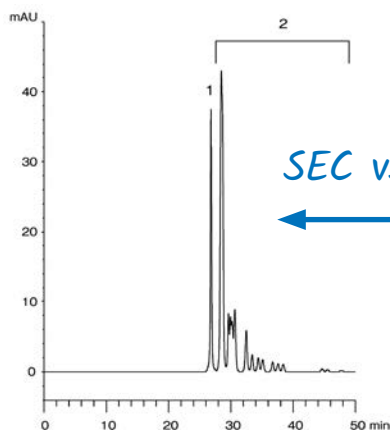

SEC vs. IEX!

1. Plasmid pBR322 Hae III digest (8-587 bp)
2. Plasmid pBR322 (4,361 bp)

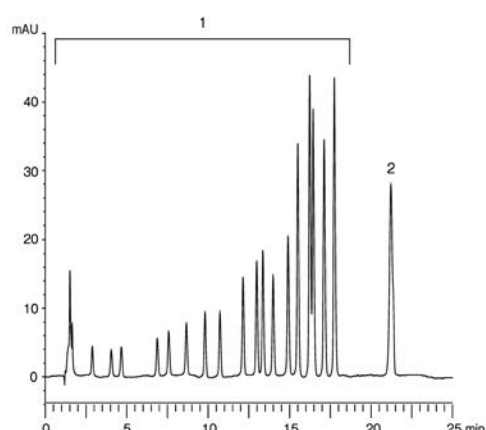

Columns: YMC-Pack Diol-300 + Diol-200 (5 μm) 500 x 8.0 mm ID  
 Part Nos.: DL30S05-5008WT + DL20S05-5008WT  
 Eluent: 0.1 M KH<sub>2</sub>PO<sub>4</sub>-K<sub>2</sub>HPO<sub>4</sub> (pH 7.0) containing 0.2 M NaCl  
 Flow rate: 0.7 mL/min  
 Temperature: ambient (25 °C)  
 Detection: UV at 260 nm  
 Injection: 10 μL

Column: BioPro IEX QF (5 μm) 100 x 4.6 mm ID  
 Part No.: QF00S05-1046WP  
 Eluent: A) 20 mM Tris-HCl (pH 8.1)  
 B) 20 mM Tris-HCl (pH 8.1) containing 0.1 M NaCl  
 Gradient: 70–85%B (0–20 min), 85%B (20–25 min)  
 Flow rate: 0.5 mL/min  
 Temperature: 35 °C  
 Detection: UV at 260 nm  
 Injection: 10 μL



RP

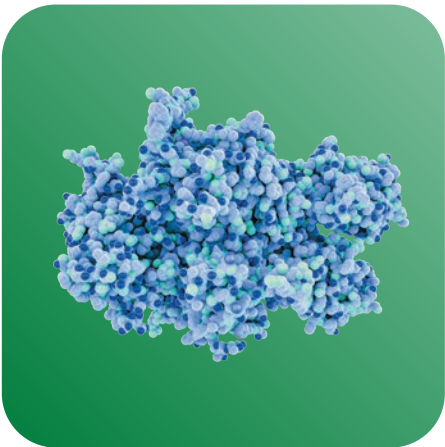

## RP – Bioseparation Columns

- Applicable to proteins, antibodies, peptides and oligonucleotides
- Selection of C18, C8 and C4 columns
- For UHPLC and HPLC
- pH- and temperature stable phases
- Superior reproducibility

### Column Selection Tool according to molecular weight

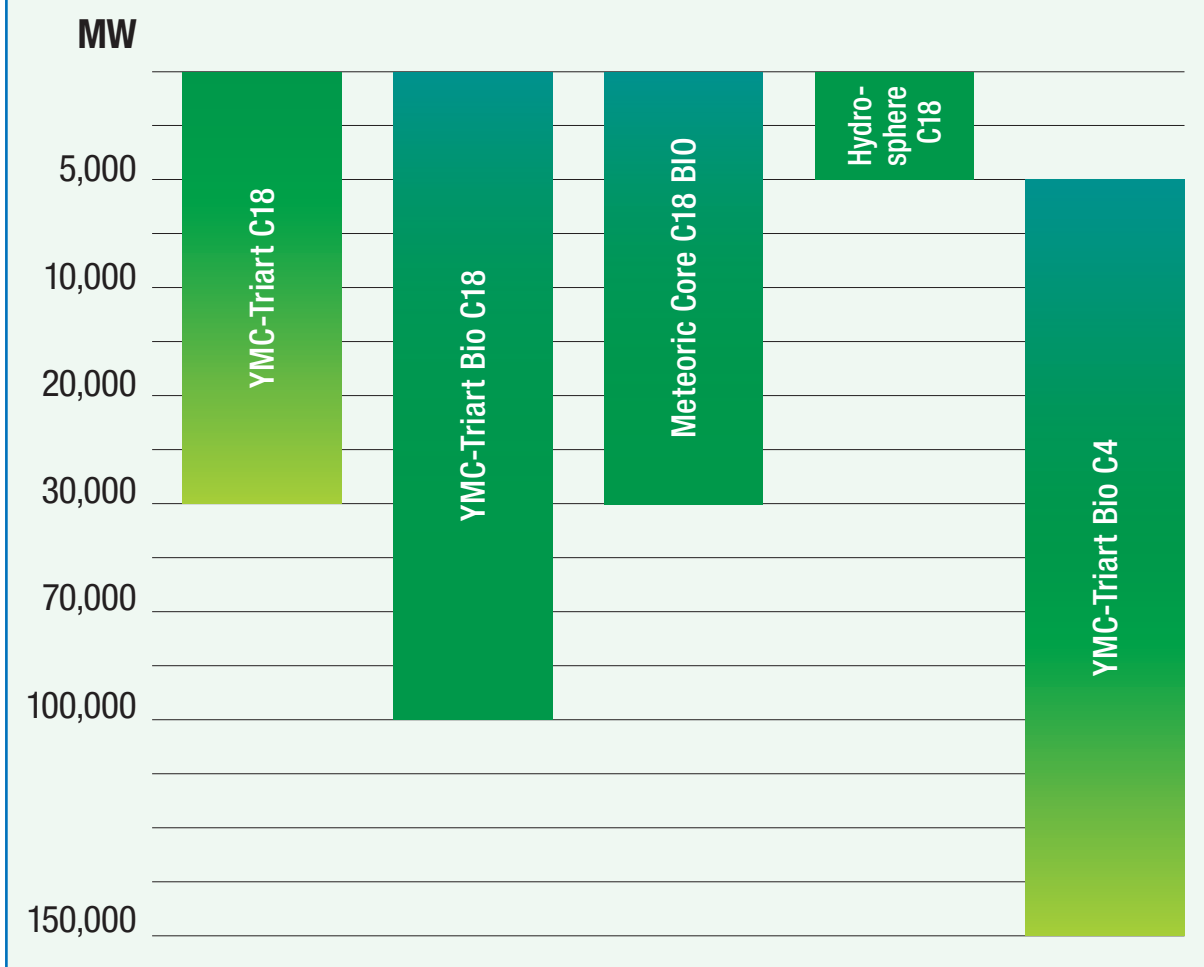

- most appropriate MW range
- extended MW range by elevated temperature
- appropriate MW range

## Influence of pore size

As shown in the table (on the left), the C18 column with 12 nm pore size is suitable for small peptides up to a MW of 5,000 Da. The highest efficiency for large peptides or small proteins can be obtained by using a wide pore C8 phase with 20 nm porosity. Most proteins can be eluted efficiently with a wide pore C4 column with 30 nm porosity.

However, the separation may also be influenced by the hydrophobicity of the peptide/protein and the nature of the column's bonded phase. Therefore, for initial method development, it can be useful, in the first instance, to follow the arrow shown in the *Column Selection Tool* for method optimisation.

Angiotensin II  
(MW 1,046)

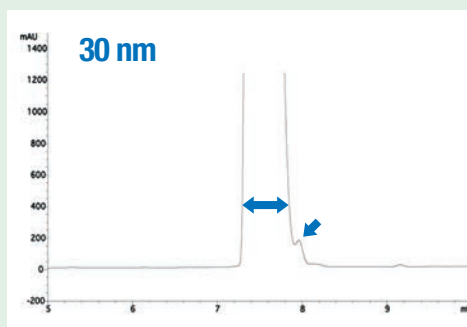
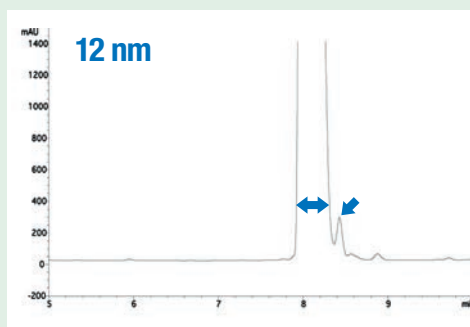

BSA  
(MW 67,000)

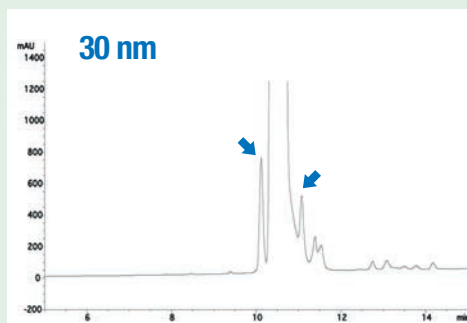
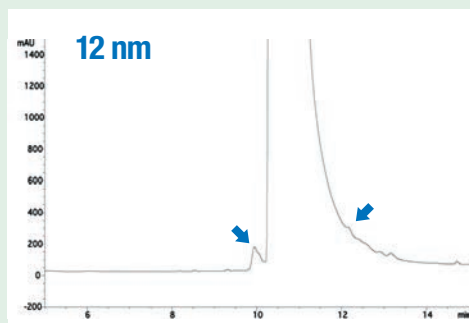

For smaller peptides a small pore size is more successful. Larger molecules are separated much better with larger pore sizes!

## RP – UHPLC / HPLC Selectivities

### Selectivities for proteins/peptides and antibodies

	YMC-Triart Bio C4	YMC-Triart C18	YMC-Triart Bio C18	Meteoric Core Bio C18
<b>Modification</b>	C4 (USP L26)	C18 (USP L1)	C18 (USP L1)	C18 (USP L1)
<b>Particle Size / <math>\mu\text{m}</math></b>	1.9, 3, 5	1.9, 3, 5	1.9, 3, 5	2.7
<b>Pore Size / nm</b>	30	12	30	8 (16)
<b>pH range</b>	1.0 – 10.0	1.0 – 12.0	1.0 – 12.0	1.5 – 10.0
<b>Temperature range</b>	pH < 7: 90 °C pH > 7: 50 °C	pH < 7: 90 °C pH > 7: 50 °C	pH < 7: 90 °C pH > 7: 50 °C	pH < 7: 70 °C pH > 7: 50 °C

### Selectivities for oligonucleotides

	YMC-Triart C18	YMC-Triart Bio C18	Hydrosphere C18	YMC-Triart C8
<b>Modification</b>	C18 (USP L1)	C18 (USP L1)	C18 (USP L1)	C8 (USP L7)
<b>Particle Size / <math>\mu\text{m}</math></b>	1.9, 3, 5	1.9, 3, 5	2, 3, 5	1.9, 3, 5
<b>Pore Size / nm</b>	12	30	12	12
<b>pH range</b>	1.0 – 12.0	1.0 – 12.0	2.0 – 8.0	1.0 – 12.0
<b>Temperature range</b>	pH < 7: 90 °C pH > 7: 50 °C	pH < 7: 90 °C pH > 7: 50 °C	50 °C	pH < 7: 90 °C pH > 7: 50 °C

*Biocompatible  
hardware available!*

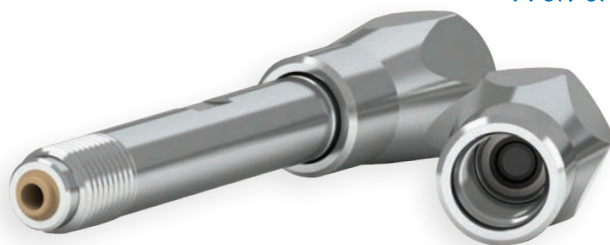

YMC-Triart **metal-free** columns are available for improved sensitivity and peak shape of coordinating compounds such as nucleotides or oligonucleotides, see page 38.



# RP – YMC-Triart Bio C4: Sharper peaks

## Better performance using YMC-Triart Bio C4

High sensitivity and sharp peaks under LC/MS compatible conditions

YMC-Triart Bio C4 (3  $\mu$ m, 30 nm)

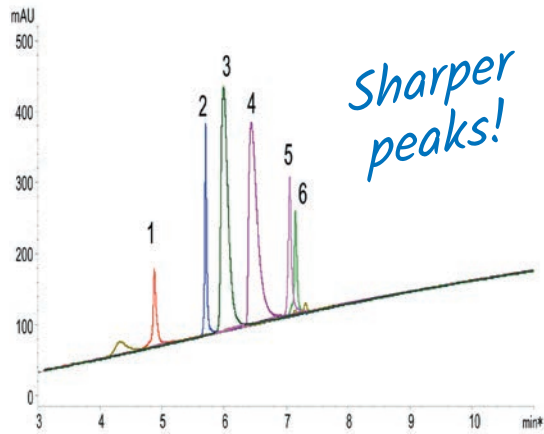

XBridge Protein BEH C4 (3.5  $\mu$ m, 30 nm)

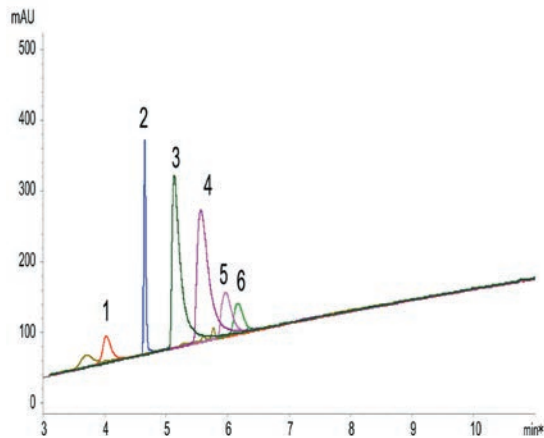

AdvanceBio RP-mAb C4 (3.5  $\mu$ m, 45 nm)

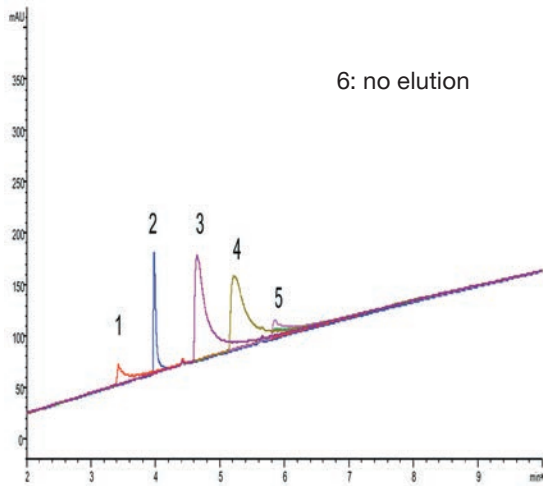

Aeris widepore C4 (3.6  $\mu$ m, 20 nm)

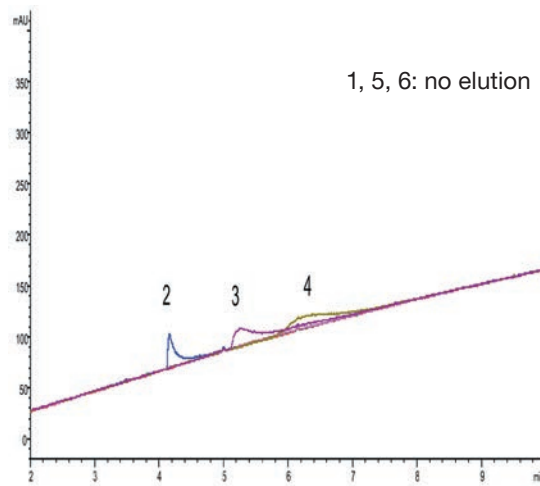

Column: 150 x 3.0 mm ID  
Part No.: TB30S03-1503PTH  
Eluent: A) water/formic acid (100/0.1)  
B) acetonitrile/formic acid (100/0.1)  
Gradient: 10–95%B (0–15 min)  
Flow rate: 0.4 mL/min (for 3.0 mm ID)  
1.0 mL/min (for 4.6 mm ID)  
Temperature: 40°C

Detection: UV at 220 nm  
Sample:  
1. Cytochrome c (Horse heart)  
2. Insulin (Bovine pancreas)  
3. Transferrin (Human)  
4. BSA  
5.  $\beta$ -Lactoglobulin (Bovine)  
6.  $\alpha$ -Chymotrypsinogen A (Bovine pancreas)

YMC-Triart Bio C4 shows better peak shape and recovery with a mobile phase containing formic acid, which is commonly used for LC/MS analysis. Therefore, YMC-Triart Bio C4 is ideal for high sensitivity analysis of proteins.

# RP – YMC-Triart Bio C4: No column adsorption

## No sample adsorption by YMC-Triart Bio C4 columns

Ideal for Microanalysis

YMC-Triart Bio C4 (1.9 μm, 30 nm)

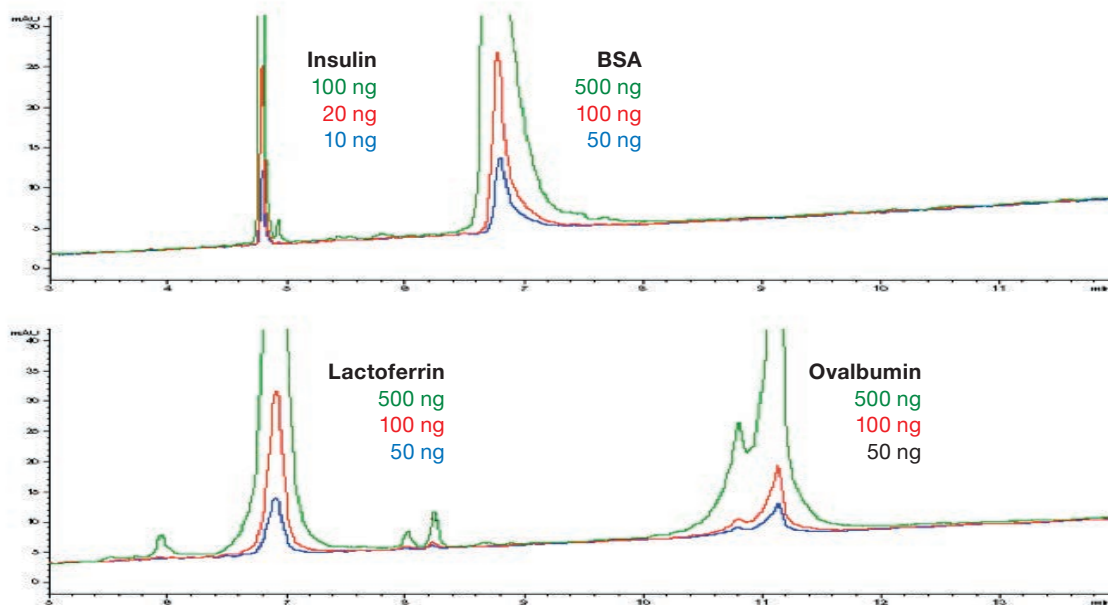

Aeris widepore C4 (3.6 μm, 20 nm)

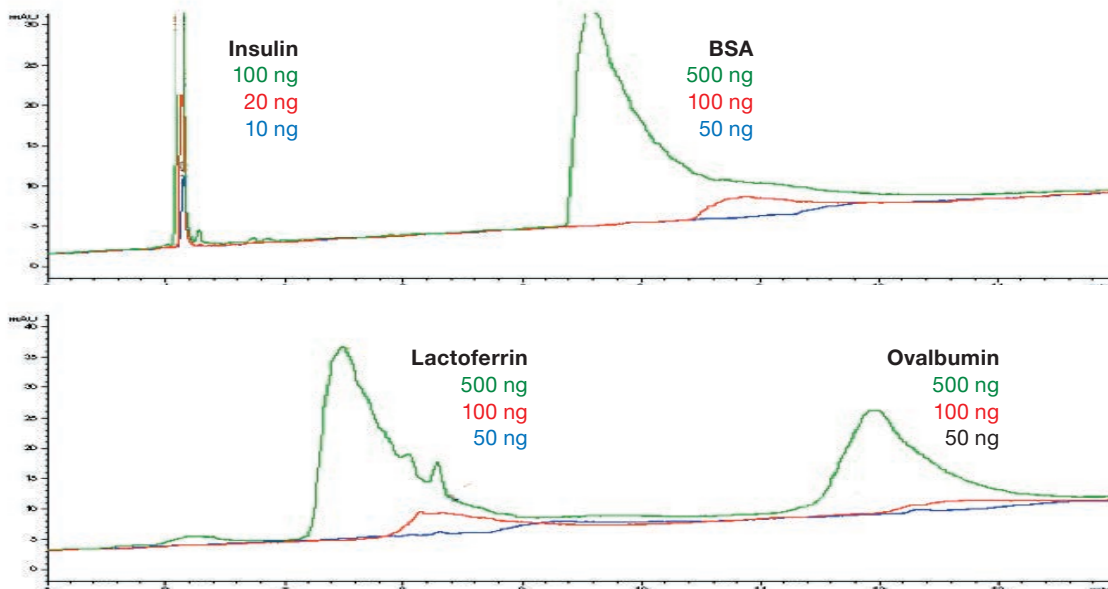

Column: 150 x 2.1 mm ID  
 Part No.: TB30SP9-15Q1PT  
 Eluent: A) water/TFA (100/0.05)  
 B) acetonitrile/TFA (100/0.05)  
 Gradient: 25-60%B (0-15 min), 90%B (15-20 min), 25%B (20-35 min)  
 Flow rate: 0.2 mL/min  
 Temperature: 40 °C  
 Detection: UV at 220 nm

No sample adsorption was observed on YMC-Triart Bio C4 even at a low sample loading. This makes YMC-Triart Bio C4 ideal for microanalysis of proteins.

## High temperature tolerance allows antibody analysis

Bevacizumab (Avastin®, MW: ca. 148 kDa)

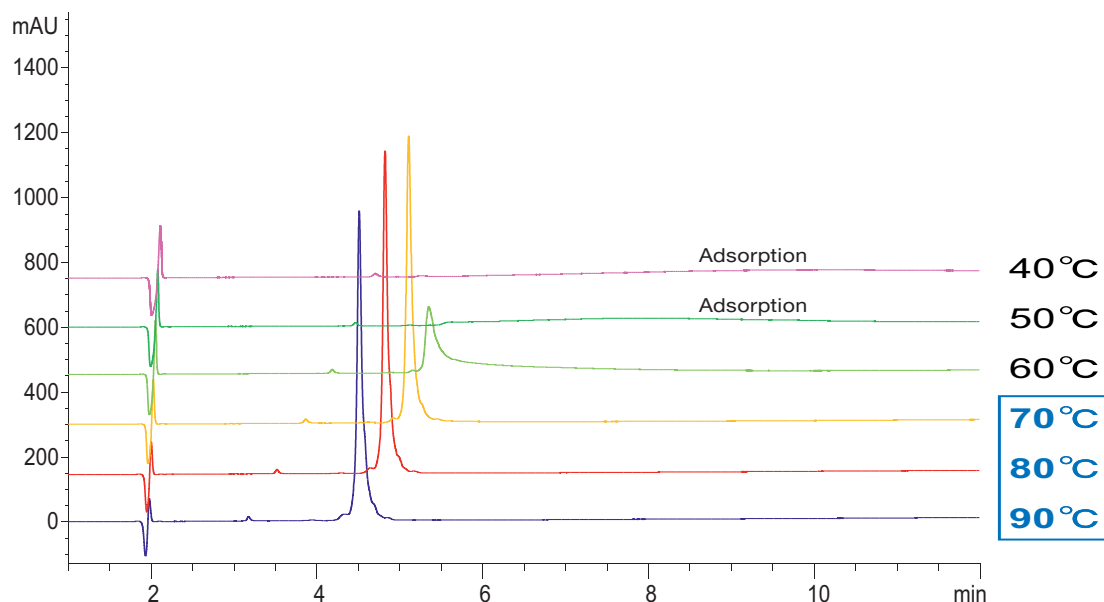

Column: YMC-Triart Bio C4 (3 µm, 30 nm) 150 x 3.0 mm ID  
Part No.: TB30S03-1503PTH  
Eluent: A) water/TFA (100/0.1)  
B) acetonitrile/TFA (100/0.1)  
Gradient: 30–60%B (0–15 min), 90%B (15–30min)  
Flow rate: 0.4 mL/min  
Detection: UV at 220 nm  
Injection: 4 µL  
Sample: Bevacizumab (0.5 mg/mL)

“

*“The possibility to use temperatures up to 90 °C with YMC-Triart Bio C4 simplifies the development of analytical methods. Furthermore, a good peak shape can be obtained without the addition of TFA, which means that I have fewer problems when using it for MS.”*

*Lars M. H. Reinders, Institute for Energy and Environmental Technology e. V. (IUTA, DE)*

”

## RP – YMC-Triart Bio C4: Reproducibility

### Excellent Batch-to-batch reproducibility for antibody analysis

NIST mAb, 8671

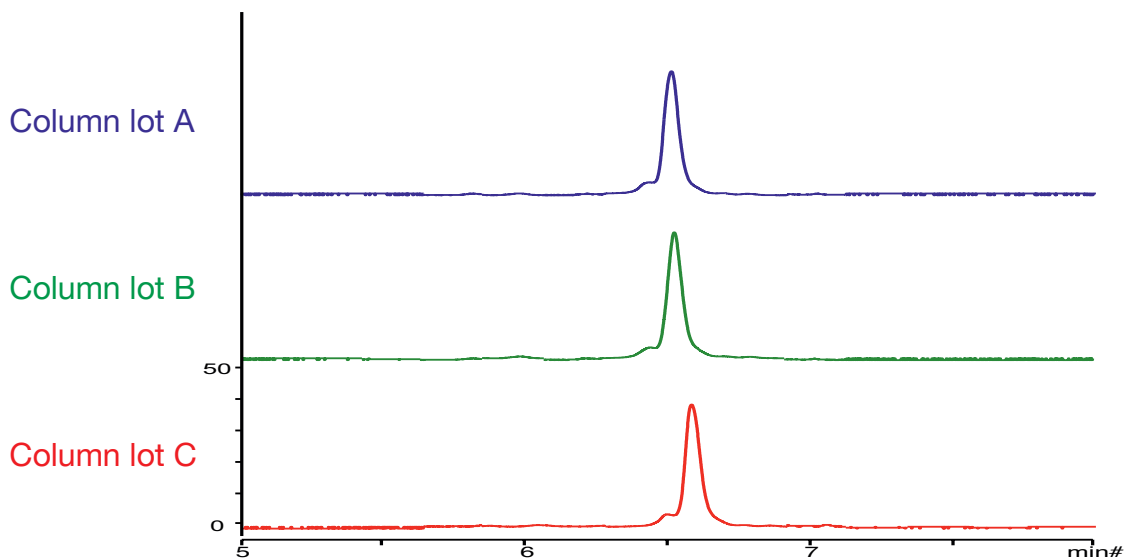

Bevacizumab (Avastin®)

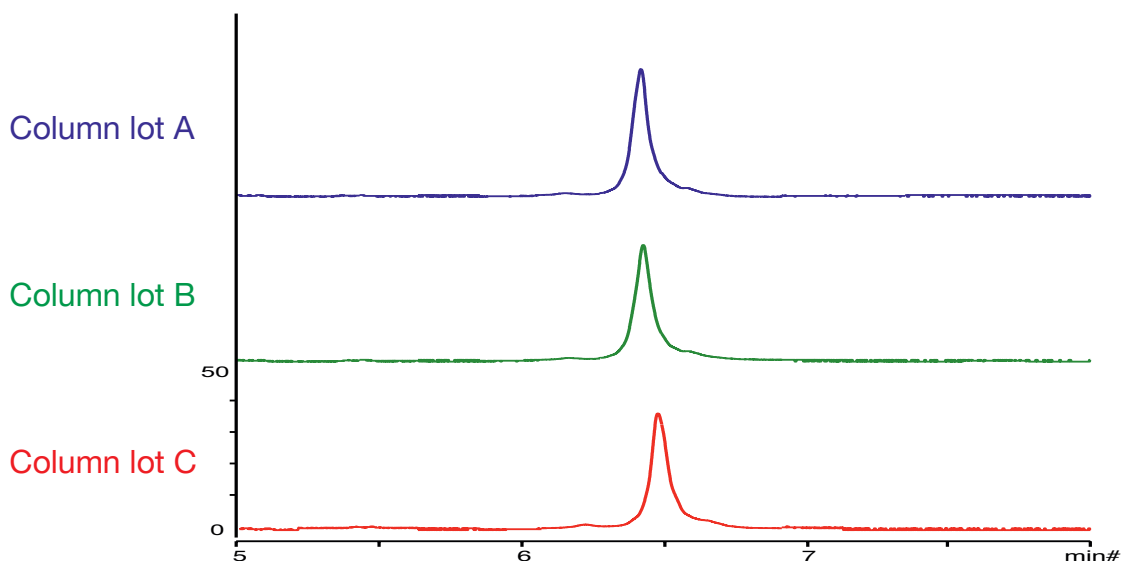

Column: YMC-Triart Bio C4 (1.9  $\mu$ m, 30 nm) 50 x 2.1 mm ID  
 Part No.: TB30SP9-05Q1PT  
 Eluent: A) water/TFA (100/0.1), B) acetonitrile/TFA (100/0.1)  
 Gradient: 25–45%B (0–10 min)  
 Flow rate: 0.4 mL/min  
 Temperature: 80 °C  
 Detection: UV at 280 nm  
 Injection: 2  $\mu$ L (0.5 mg/mL)

YMC-Triart Bio C4 shows excellent lot-to-lot reproducibility for antibodies. Not only is retention time highly reproducible, but also the resolution of minor impurity peaks. This makes YMC-Triart Bio C4 ideal for quality control of biopharmaceuticals.

# RP – YMC-Triart C18: Temperature stability

## More temperature flexibility using YMC-Triart

### Highly efficient RP-HPLC separation of proteins

#### Mixture A (MW 500–18,400)

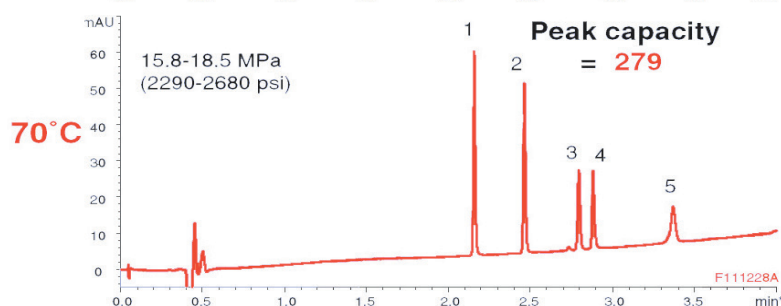
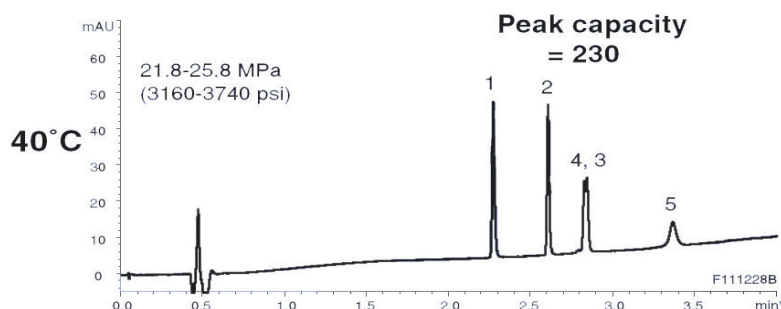

Analytes	MW	Peak width ½h (min)	
		40 °C	70 °C

#### Mixture A

1. Oxytocin	1,007	0.017	0.014
2. Leu-Enkephalin	556	0.015	0.015
3. β-Endorphin	3,465	—	0.016
4. Insulin	5,733	—	0.015
5. β-Lactoglobulin A	18,400	0.043	0.030

#### Mixture B

1. Lysozyme	14,300	0.069	0.044
2. α-Chymotrypsinogen	25,700	0.080	0.049
3. β-Lactoglobulin A	18,400	0.080	0.048

#### Mixture B (MW 14,300–25,700)

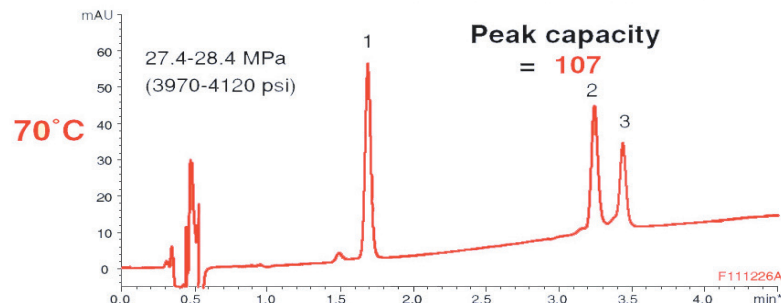
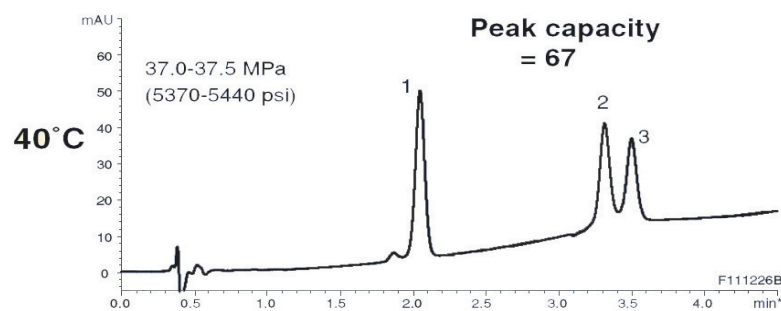

*High temperatures only possible with YMC-Triart*

Column: YMC-Triart C18 (1.9 μm, 12 nm) 50 x 2.0 mm ID  
 Part-No.: TA12SP9-0502WT  
 Eluent: A) water / TFA (100/0.1)  
 B) acetonitrile / TFA (100/0.1) - mixture A  
 B) acetonitrile / 2-propanol / TFA (50/50/0.1) - mixture B  
 Gradient: 10–80%B (0–5 min) - mixture A  
 30–60%B (0–5 min) - mixture B

Flow rate: 0.4 mL/min  
 Detection: UV at 220 nm  
 Injection: 1 μL (50 μg/mL) - condition A  
 1 μL (250 μg/mL) - condition B  
 System: Agilent 1200SL

PC (peak capacity) = 1 + (gradient time / peak width\*)  
 \*peak width = 2W<sub>0.5h</sub> average

# RP – YMC-Triart Bio C18: Great peak shapes

## Ideal solutions for any kind of biomolecule

### Separation of Somatropin (MW 22,125 Da)

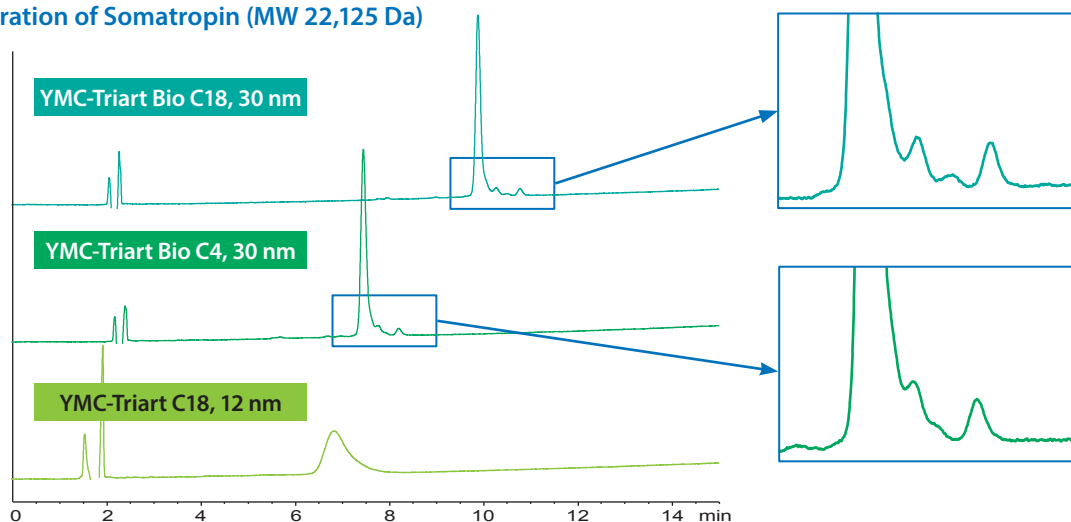

Columns: 150 x 3.0 mm ID (3  $\mu$ m)  
 Part Nos.: TA30S03-1503PTH  
 TB30S03-1503PTH  
 TA12S03-1503PTH  
 Eluent: A) water/TFA (100/0.1)  
 B) acetonitrile/TFA (100/0.08)

Gradient: 50–70%B (0–15 min)  
 Flow rate: 0.425 mL/min  
 Temperature: 40 °C  
 Detection: UV at 220 nm  
 Injection: 4  $\mu$ L  
 Sample: Somatropin (0.1 mg/mL)

In this example of somatropin, a peptide of 22,125 Da, good peak shape can be obtained with the widepore columns YMC-Triart Bio C18 and YMC-Triart Bio C4. Excellent separation was achieved using YMC-Triart Bio C18 with longer alkyl chains in its bonded phase.

## Ideal for MS conditions

### Good peak shape with mobile phase containing formic acid

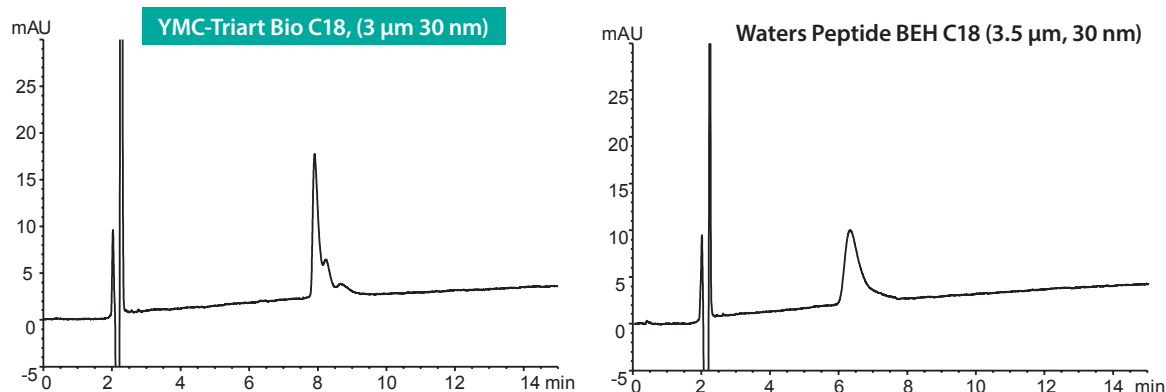

Column: 150 x 3.0 mm ID; 150 x 4.6 mm ID  
 Part No.: TA30S03-1503PTH  
 Eluent: A) water/formic acid (100/0.1)  
 B) acetonitrile/formic acid (100/0.08)  
 Gradient: 45–65%B (0–15 min)

Flow rate: 0.425 mL/min for 3.0 mm ID; 1.0 mL/min for 4.6 mm ID  
 Temperature: 40 °C  
 Detection: UV at 220 nm  
 Sample: Somatropin (0.1 mg/mL)

YMC-Triart Bio C18 is suitable for highly sensitive analysis and structural analysis of proteins using LC/MS since good peak shapes in mobile phase containing formic acid can be achieved.

# RP – Hydrosphere C18: Oligonucleotide purification

## Easy purification of Oligonucleotides with YMC-Actus semi prep columns

### Purification of synthetic 30mer oligonucleotide

**Analysis** 1.0 mL/min, 5  $\mu$ L injection  
**Hydrosphere C18**  
 50 x 4.6 mm ID, 5  $\mu$ m

**Purification** 19 mL/min, 100  $\mu$ L injection  
**YMC-Actus Hydrosphere C18**  
 50 x 20 mm ID, 5  $\mu$ m

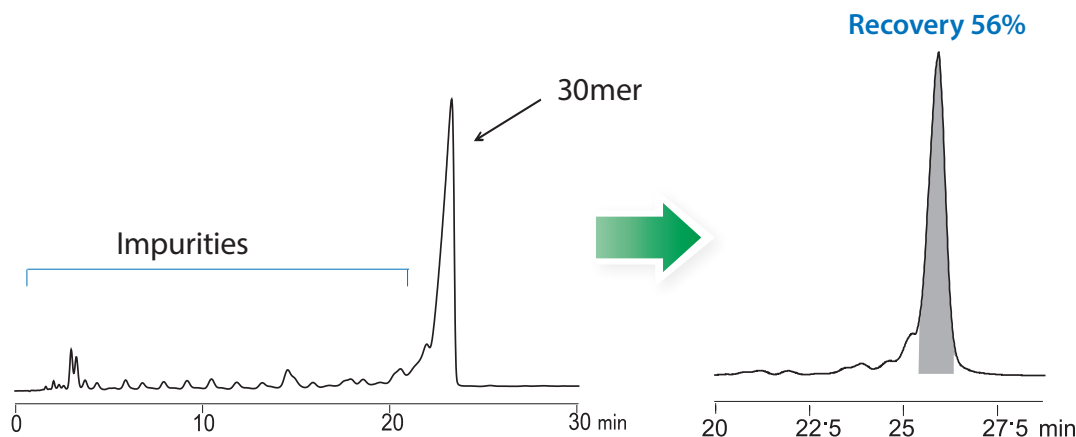

Part Nos.: HS12S05-0546WT  
 HS12S05-0520WX  
 Eluent: A) 10 mM DBA-acetic acid (pH 6.0) / methanol (60/40)  
 B) 10 mM DBA-acetic acid (pH 6.0) / methanol (20/80)  
 Gradient: 10%–35%B (0–30 min.)  
 Temperature: ambient  
 Detection: UV at 269 nm  
 Sample: synthetic oligonucleotide (100  $\mu$ M)

purity > 99%

## Influences of mobile phase conditions on intensity of ESI-MS

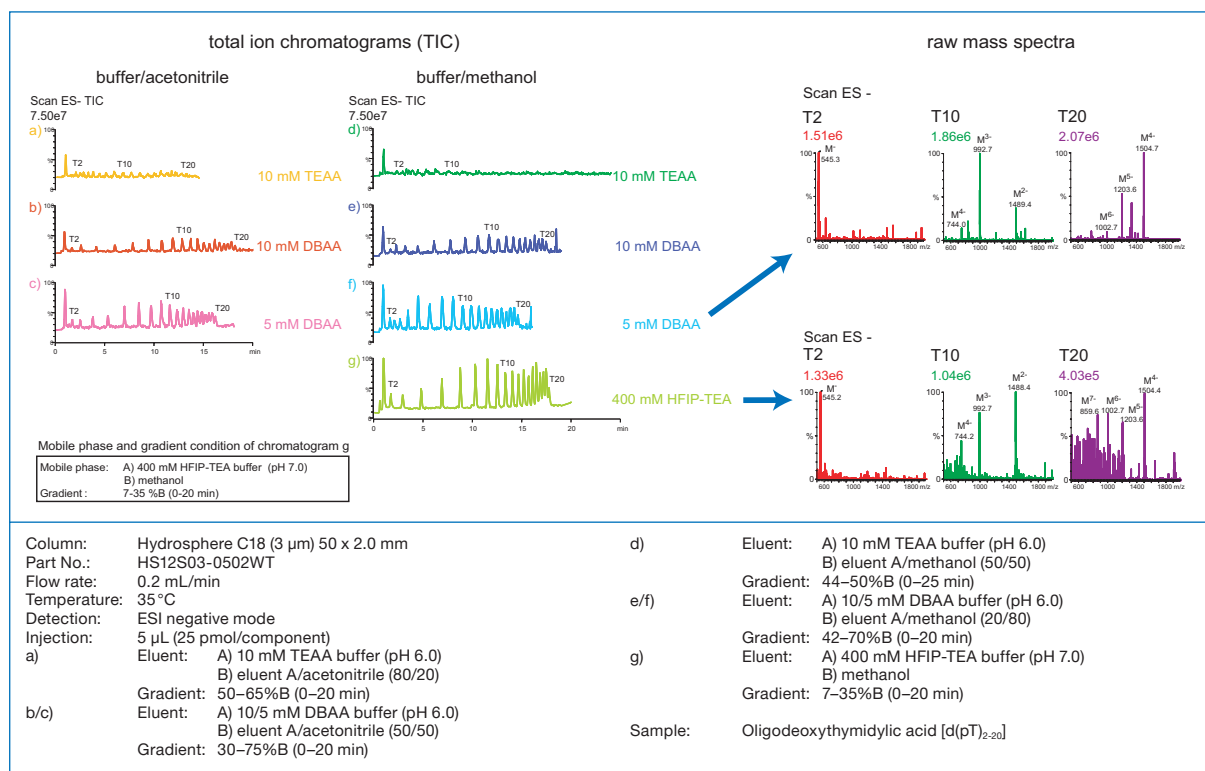

# RP – YMC-Triart: Biocompatible hardware

## Metal-free column hardware ideal for oligonucleotide analysis

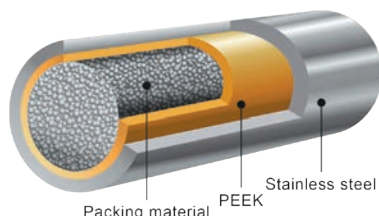

Specifications	
YMC-Triart Phases	C18, Bio C18, C8, Bio C4
Particle Size	1.9, 3, 5 $\mu\text{m}$
Inner layer	PEEK
Outer layer	Stainless steel
Frit	PEEK
Pressure limit	1.9 $\mu\text{m}$ : 100 MPa (15,000 psi) 3/5 $\mu\text{m}$ : 45 MPa (6,525 psi)

Special column connectors required.  
See ordering information recommendations.

### Improved sensitivity for coordination compounds

1. ATP

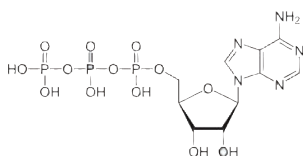

2. ADP

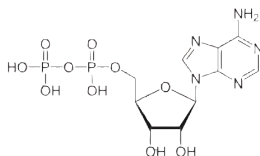

3. AMP

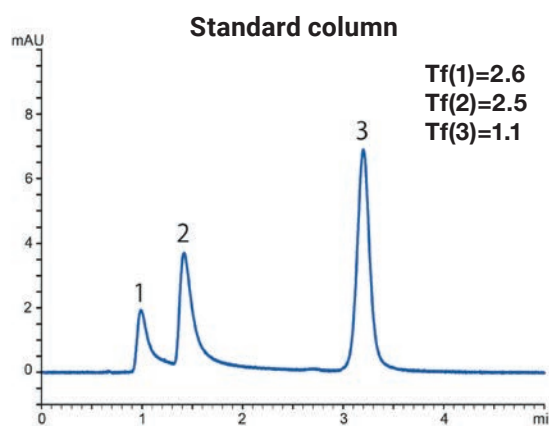
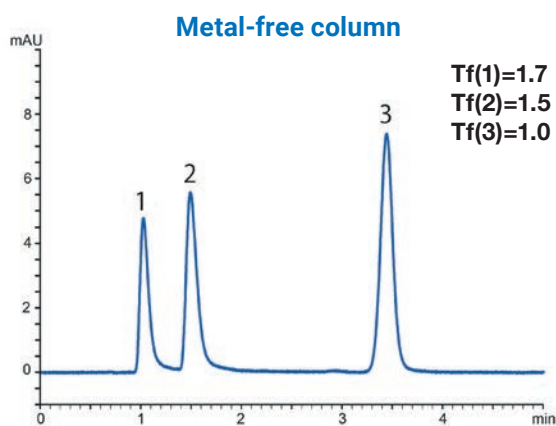
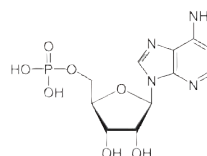

Column: YMC-Triart C18 (3  $\mu\text{m}$ ) 50 x 2.1 mm ID  
 Part Nos.: TA12S03-05Q1PTP (**metal-free**) or  
 TA12S03-05Q1PTH (regular hardware)  
 Eluent: 5 mM  $\text{HCOONH}_4$   
 Flow rate: 0.21 mL/min  
 Temperature: 25  $^\circ\text{C}$   
 Detection: UV at 265 nm  
 Injection: 1  $\mu\text{L}$  (10 mg/mL)  
 System: bioinert/"non-metal" HPLC system

Metal coordinating compounds, which have a phosphate group in their structure, tend to show poor peak shape due to interactions with metals, such as the stainless steel in column bodies and frits. By using the **metal-free** column hardware, better peak shapes can be expected. Nucleotides with phosphate groups show better peak shapes when compared to the regular column hardware. The **metal-free** column hardware is very suitable for highly sensitive analyses using LC/MS.



## Use of MS compatible conditions for antibody analysis by RP

Although the best peak shapes and greater sensitivity can be provided by mobile phases containing TFA, suitable peaks can also be obtained with mobile phases containing formic acid – especially in combination with YMC-Triart Bio C4.

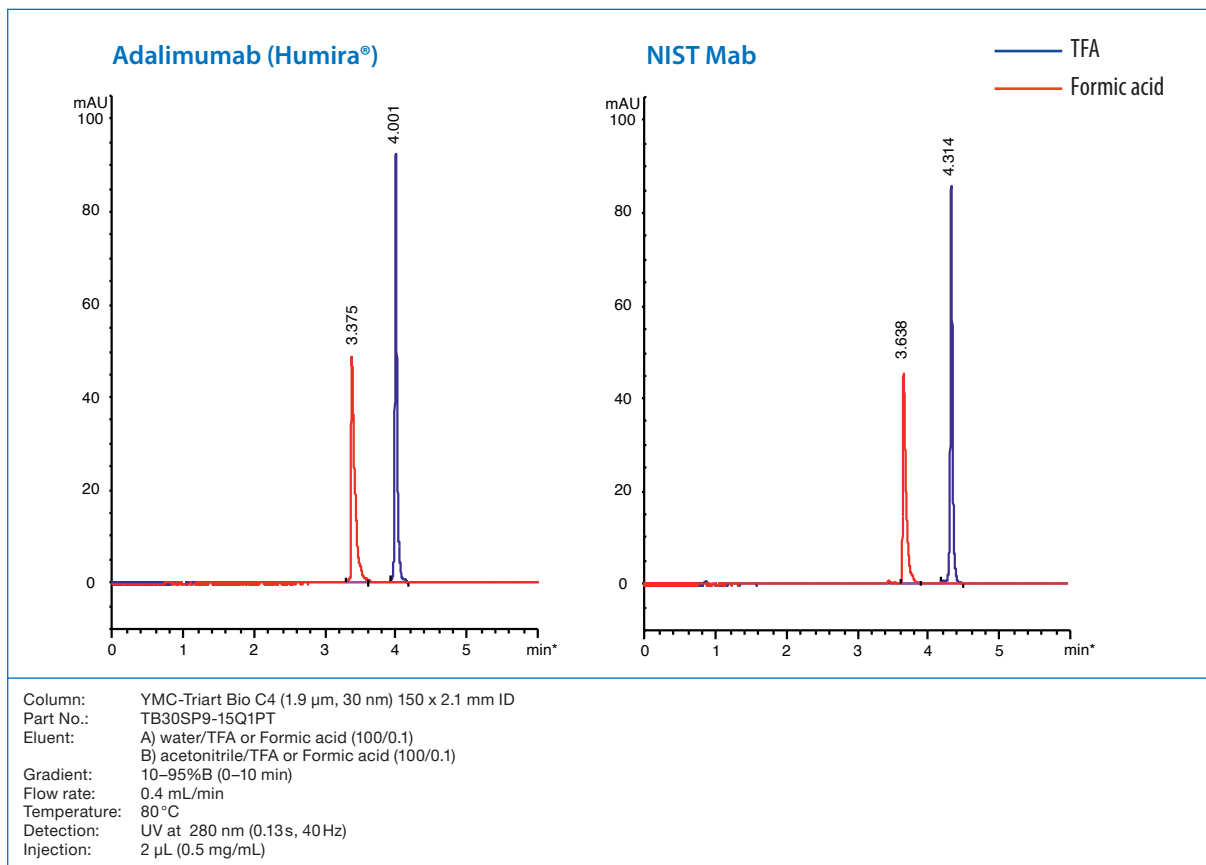

# RP – Expert Tips: (Oligo)nucleotides

## Influence of system and column hardware on the analysis of nucleotides

1 ATP

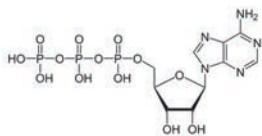

2 ADP

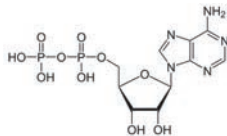

3 AMP

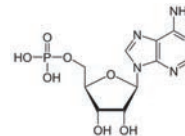

Ordinary HPLC system with standard column

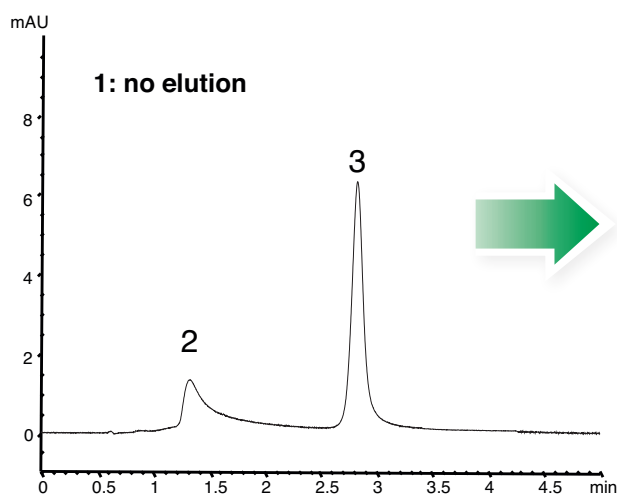

Ordinary HPLC system with metal-free column

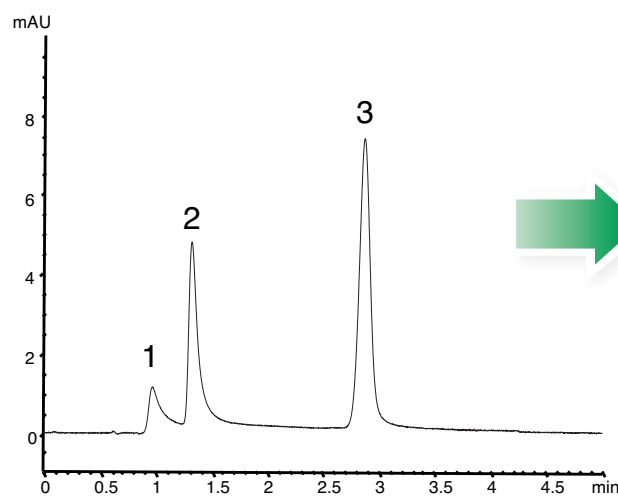

Column: YMC-Triart C18 (3  $\mu$ m, 12 nm) 50 x 2.1 mm ID  
 Part Nos: TA12S03-05Q1PT (standard hardware)  
 TA12S03-05Q1PTP (metal-free hardware)  
 Eluent: 5 mM HCOONH<sub>4</sub>  
 Flow rate: 0.21 mL/min  
 Temperature: 25 °C  
 Detection: UV at 265 nm  
 Injection: 1  $\mu$ L (10  $\mu$ g/mL)

"Non-metal" HPLC system: PEEK sample loop, PEEK injector port, and PEEK tubing are used.

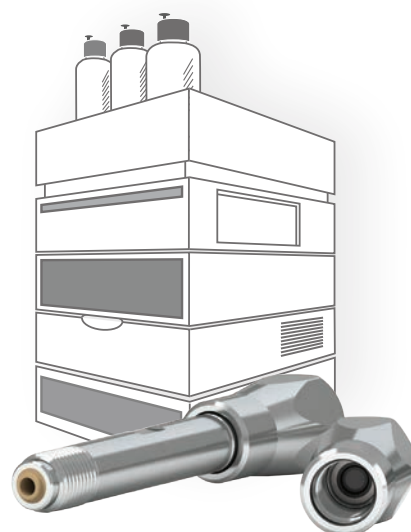
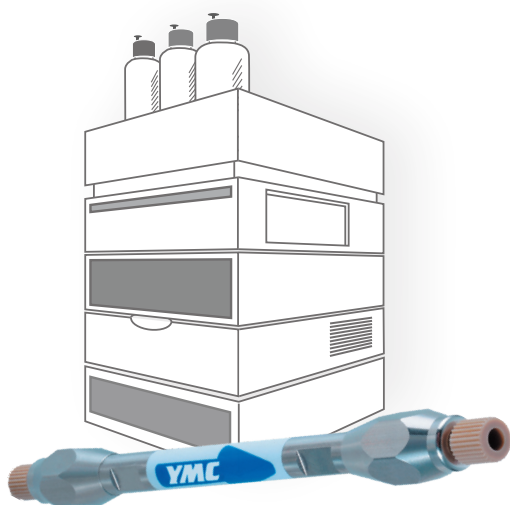

ATP peak is detected, and peak shape of ADP is improved as a result of using the metal-free column.

Ordinary HPLC system  
with metal-free column

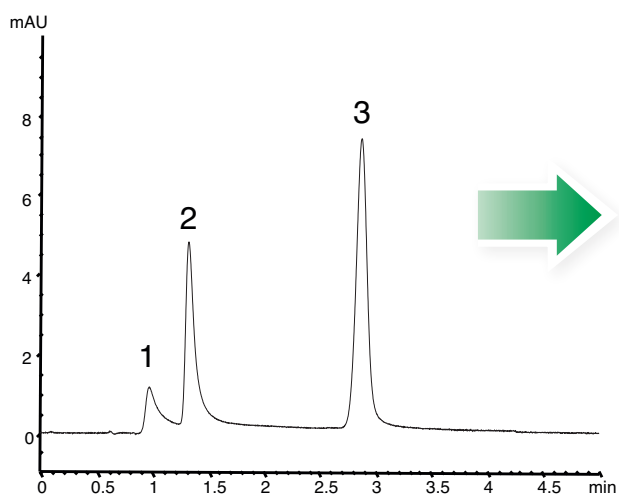

“Non-metal” HPLC system\*  
with metal-free column

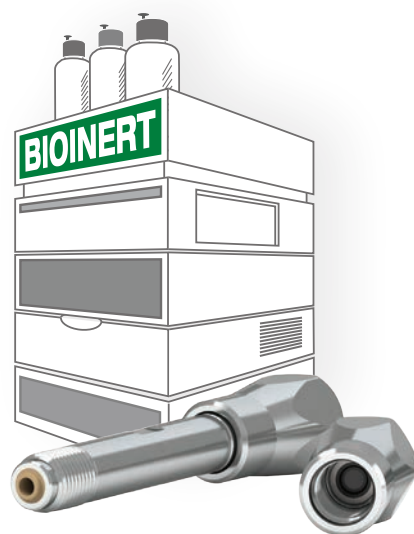
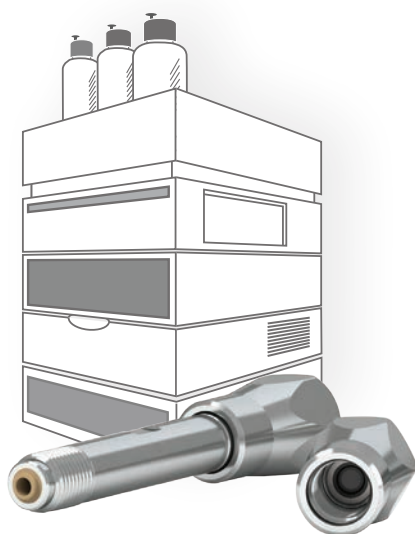
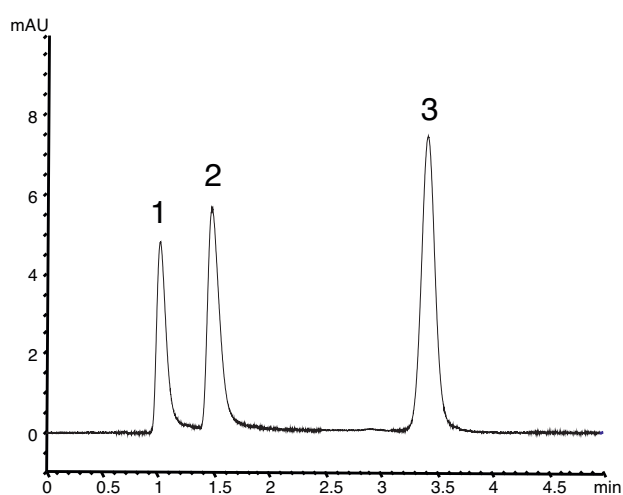

Peak shape is greatly improved as a result of using “non-metal” HPLC system

## RP – Expert Tips: Oligonucleotides

### Effect of composition and salt concentration of ion-pairing mobile phase on the separation and signal intensity

Comparison of separation and ESI-MS signal intensity using different ion-pairing buffers and organic solvents

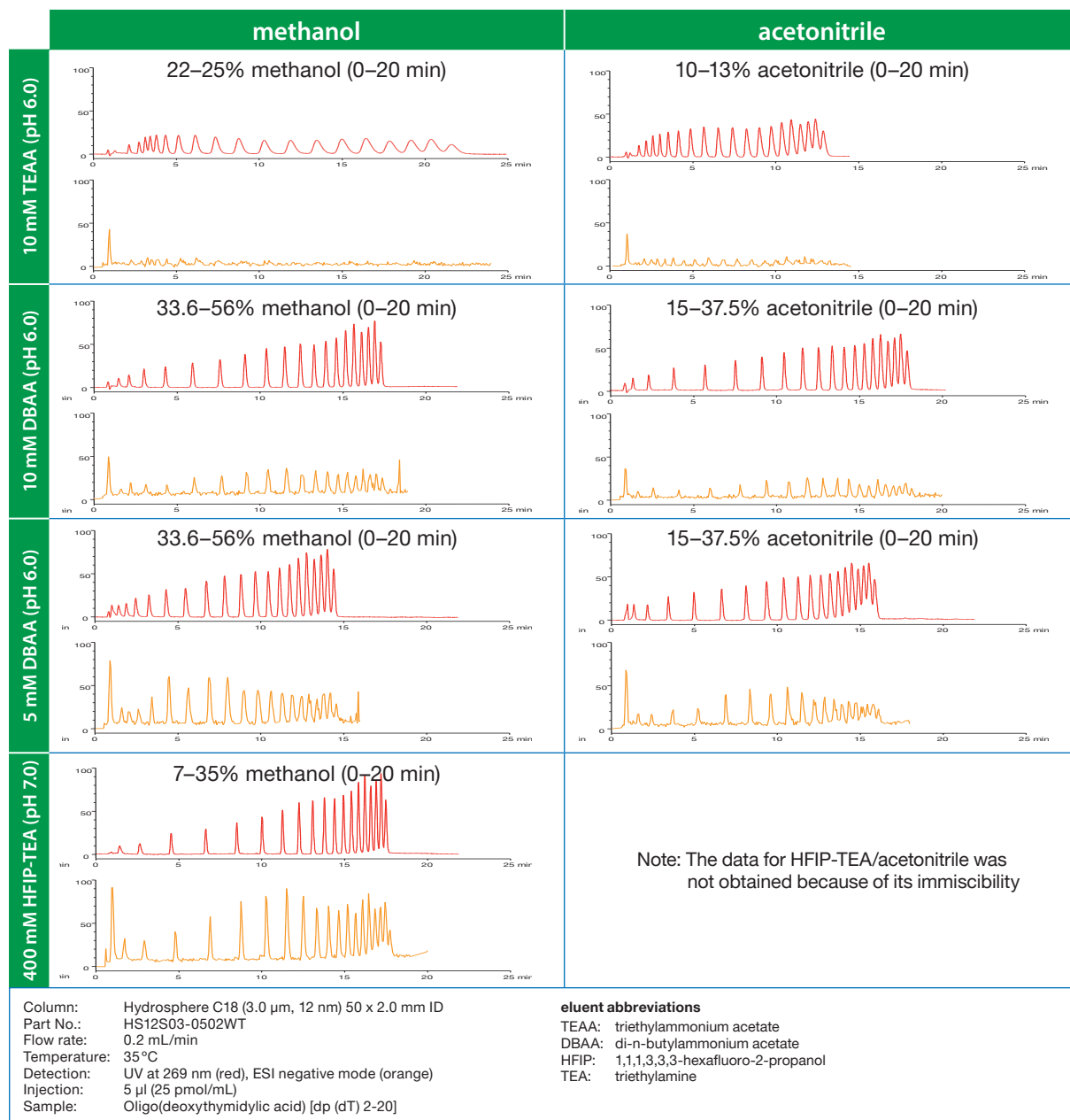

The mobile phase composition has different effects on the separation and signal intensity in electrospray ionisation mass spectrometry (ESI-MS) of oligonucleotides. Using different gradient conditions, acceptable retention and resolution can be achieved (upper UV chromatograms; red trace) for each separation by optimising the gradient slope of the organic solvent regardless of the type of mobile phase. The ESI-MS intensity is significantly influenced by

the type and concentration of ion-pairing buffer as shown in the lower MS chromatograms (orange trace). HFIP-TEA buffer/methanol systems provide the maximum MS intensity. Enhanced retention and MS intensity are obtained using 10 mM DBAA buffer compared to 10 mM TEAA buffer, and the lower DBAA concentration results in approximately 1.5–3 times increase in the intensity without any change in the concentration of organic solvent.

## 1.9 µm UHPLC columns

Phase	Column ID [mm]	Column length [mm]					Guard cartridges* with 5 mm length (pack of 3)
		30	50	75	100	150	
YMC-Triart C18	2.0	TA12SP9-0302PT	TA12SP9-0502PT	TA12SP9-L502PT	TA12SP9-1002PT	TA12SP9-1502PT	TA12SP9-E5Q1CC**
	2.1	TA12SP9-03Q1PT	TA12SP9-05Q1PT	TA12SP9-L5Q1PT	TA12SP9-10Q1PT	TA12SP9-15Q1PT	TA12SP9-E5Q1CC**
	3.0	—	TA12SP9-0503PT	TA12SP9-L503PT	TA12SP9-1003PT	TA12SP9-1503PT	TA12SP9-E503CC
YMC-Triart Bio C18	2.0	TA30SP9-0302PT	TA30SP9-0502PT	TA30SP9-L502PT	TA30SP9-1002PT	TA30SP9-1502PT	TA30SP9-E5Q1CC**
	2.1	TA30SP9-03Q1PT	TA30SP9-05Q1PT	TA30SP9-L5Q1PT	TA30SP9-10Q1PT	TA30SP9-15Q1PT	TA30SP9-E5Q1CC**
	3.0	—	TA30SP9-0503PT	TA30SP9-L503PT	TA30SP9-1003PT	TA30SP9-1503PT	TA30SP9-E503CC
YMC-Triart C8	2.0	T012SP9-0302PT	T012SP9-0502PT	T012SP9-L502PT	T012SP9-1002PT	T012SP9-1502PT	T012SP9-E5Q1CC**
	2.1	T012SP9-03Q1PT	T012SP9-05Q1PT	T012SP9-L5Q1PT	T012SP9-10Q1PT	T012SP9-15Q1PT	T012SP9-E5Q1CC**
	3.0	—	T012SP9-0503PT	T012SP9-L503PT	T012SP9-1003PT	T012SP9-1503PT	T012SP9-E503CC
YMC-Triart Bio C4	2.0	TB30SP9-0302PT	TB30SP9-0502PT	TB30SP9-L502PT	TB30SP9-1002PT	TB30SP9-1502PT	TB30SP9-E5Q1CC**
	2.1	TB30SP9-03Q1PT	TB30SP9-05Q1PT	TB30SP9-L5Q1PT	TB30SP9-10Q1PT	TB30SP9-15Q1PT	TB30SP9-E5Q1CC**
	3.0	—	TB30SP9-0503PT	TB30SP9-L503PT	TB30SP9-1003PT	TB30SP9-1503PT	TB30SP9-E503CC

\*Guard cartridge holder required, part no. XPCHUHP





\*\*Guard cartridge: 2.1 mm ID

## 1.9 µm metal-free UHPLC columns

Phase	Column ID [mm]	Column length [mm]		
		50	100	150
YMC-Triart C18	2.1	TA12SP9-05Q1PTP	TA12SP9-10Q1PTP	TA12SP9-15Q1PTP
YMC-Triart Bio C18	2.1	TA30SP9-05Q1PTP	TA30SP9-10Q1PTP	TA30SP9-15Q1PTP
YMC-Triart C8	2.1	T012SP9-05Q1PTP	T012SP9-10Q1PTP	T012SP9-15Q1PTP
YMC-Triart Bio C4	2.1	TB30SP9-05Q1PTP	TB30SP9-10Q1PTP	TB30SP9-15Q1PTP

Special column connectors required.

## Column connectors for metal-free (U)HPLC columns

Recommendation	✓ ✓		✓	
Ferrule	no		replaceable	
Product	MarvelX™	MarvelXACT™	Handy connector 2	Hand-tight EXP® fitting
Manufacturer	IDEX Health & Science LLC	IDEX Health & Science LLC	YMC Co., Ltd.	Optimize Technologies, Inc.
				
Pressure rating	131 MPa / 1,310 bar	131 MPa / 1,310 bar	42 MPa / 420 bar	137 MPa / 1,370 bar
Product code	e.g. UPPF-6050250	e.g. UPPF-YM7050250	XRP0204	XRHTF-01

MarvelX (ACT) is a registered trademark of IDEX Health & Science LLC · EXP® is a registered trademark of Optimize Technologies, Inc.

## RP – Ordering information

### 3 µm HPLC columns

Phase	Column ID [mm]	Column length [mm]						Guard cartridges* with 10 mm length (pack of 5)
		30/33	50	75	100	150	250	
YMC-Triart C18	2.1	TA12S03-H3Q1PTH	TA12S03-05Q1PTH	TA12S03-L5Q1PTH	TA12S03-10Q1PTH	TA12S03-15Q1PTH	–	TA12S03-01Q1GC
	3.0	–	TA12S03-05Q3PTH	TA12S03-L5Q3PTH	TA12S03-10Q3PTH	TA12S03-15Q3PTH	–	TA12S03-01Q3GC
	4.6	TA12S03-H346PTH	TA12S03-0546PTH	TA12S03-L546PTH	TA12S03-1046PTH	TA12S03-1546PTH	TA12S03-2546PTH	TA12S03-01Q4GC
YMC-Triart Bio C18	2.1	TA30S03-H3Q1PTH	TA30S03-05Q1PTH	TA30S03-L5Q1PTH	TA30S03-10Q1PTH	TA30S03-15Q1PTH	–	TA30S03-01Q1GC
	3.0	–	TA30S03-05Q3PTH	TA30S03-L5Q3PTH	TA30S03-10Q3PTH	TA30S03-15Q3PTH	–	TA30S03-01Q3GC
	4.6	TA30S03-H346PTH	TA30S03-0546PTH	TA30S03-L546PTH	TA30S03-1046PTH	TA30S03-1546PTH	TA30S03-2546PTH	TA30S03-01Q4GC
YMC-Triart C8	2.1	T012S03-H3Q1PTH	T012S03-05Q1PTH	T012S03-L5Q1PTH	T012S03-10Q1PTH	T012S03-15Q1PTH	–	T012S03-01Q1GC
	3.0	–	T012S03-05Q3PTH	T012S03-L5Q3PTH	T012S03-10Q3PTH	T012S03-15Q3PTH	–	T012S03-01Q3GC
	4.6	T012S03-H346PTH	T012S03-0546PTH	T012S03-L546PTH	T012S03-1046PTH	T012S03-1546PTH	T012S03-2546PTH	T012S03-01Q4GC
YMC-Triart Bio C4	2.1	TB30S03-03Q1PTH	TB30S03-05Q1PTH	TB30S03-L5Q1PTH	TB30S03-10Q1PTH	TB30S03-15Q1PTH	–	TB30S03-01Q1GC
	3.0	–	TB30S03-05Q3PTH	TB30S03-L5Q3PTH	TB30S03-10Q3PTH	TB30S03-15Q3PTH	–	TB30S03-01Q3GC
	4.6	TB30S03-0346PTH	TB30S03-0546PTH	TB30S03-L546PTH	TB30S03-1046PTH	TB30S03-1546PTH	TB30S03-2546PTH	TB30S03-01Q4GC
Hydrosphere C18	2.1	HS12S03-03Q1WT	HS12S03-05Q1WT	HS12S03-L5Q1WT	HS12S03-10Q1WT	HS12S03-15Q1WT	HS12S03-25Q1WT	HS12S03-01Q1GC
	3.0	HS12S03-03Q3WT	HS12S03-05Q3WT	HS12S03-L5Q3WT	HS12S03-10Q3WT	HS12S03-15Q3WT	HS12S03-25Q3WT	HS12S03-01Q3GC
	4.6	HS12S03-0346WT	HS12S03-0546WT	HS12S03-L546WT	HS12S03-1046WT	HS12S03-1546WT	HS12S03-2546WT	HS12S03-01Q4GC
YMCbasic (eq. C8)	2.1	BA99S03-03Q1WT	BA99S03-05Q1WT	BA99S03-L5Q1WT	BA99S03-10Q1WT	BA99S03-15Q1WT	BA99S03-25Q1WT	BA99S03-01Q1GC
	3.0	BA99S03-03Q3WT	BA99S03-05Q3WT	BA99S03-L5Q3WT	BA99S03-10Q3WT	BA99S03-15Q3WT	BA99S03-25Q3WT	BA99S03-01Q3GC
	4.6	BA99S03-0346WT	BA99S03-0546WT	BA99S03-L546WT	BA99S03-1046WT	BA99S03-1546WT	BA99S03-2546WT	BA99S03-01Q4GC

\*Guard cartridge holder required, part no. XPGCH-Q1

### 3 µm metal-free HPLC columns

Phase	Column ID [mm]	Column length [mm]		
		50	100	150
YMC-Triart C18	2.1	TA12S03-05Q1PTP	TA12S03-10Q1PTP	TA12S03-15Q1PTP
	4.6	TA12S03-0546PTP	TA12S03-1046PTP	TA12S03-1546PTP
YMC-Triart Bio C18	2.1	TA30S03-05Q1PTP	TA30S03-10Q1PTP	TA30S03-15Q1PTP
	4.6	TA30S03-0546PTP	TA30S03-1046PTP	TA30S03-1546PTP
YMC-Triart C8	2.1	T012S03-05Q1PTP	T012S03-10Q1PTP	T012S03-15Q1PTP
	4.6	T012S03-0546PTP	T012S03-1046PTP	T012S03-1546PTP
YMC-Triart Bio C4	2.1	TB30S03-05Q1PTP	TB30S03-10Q1PTP	TB30S03-15Q1PTP
	4.6	TB30S03-0546PTP	TB30S03-1046PTP	TB30S03-1546PTP

Special column connectors required.

## 2.7 µm Core-Shell columns

Phase	Column ID [mm]	Column length [mm]					Precolumn filter 0.5 µm
		30	50	75	100	150	
							(pack of 3)
<b>Meteoritic Core C18 BIO, 16 nm</b>	2.1	CAW16SQ7-03Q1PT	CAW16SQ7-05Q1PT	CAW16SQ7-L5Q1PT	CAW16SQ7-10Q1PT	CAW16SQ7-15Q1PT	XRPRCS35
	3.0	CAW16SQ7-0303PT	CAW16SQ7-0503PT	CAW16SQ7-L503PT	CAW16SQ7-1003PT	CAW16SQ7-1503PT	
	4.6	CAW16SQ7-0346PT	CAW16SQ7-0546PT	CAW16SQ7-L546PT	CAW16SQ7-1046PT	CAW16SQ7-1546PT	

\*Holder required, part no. XRPRCS03

## 5 µm HPLC columns

Phase	Column ID [mm]	Column length [mm]						Guard cartridges* with 10 mm length
		30/33	50	75	100	150	250	
								(pack of 5)
<b>YMC-Triart C18</b>	2.1	TA12S05-H3Q1PTH	TA12S05-05Q1PTH	TA12S05-L5Q1PTH	TA12S05-10Q1PTH	TA12S05-15Q1PTH	–	TA12S05-01Q1GC
	3.0	–	TA12S05-0503PTH	TA12S05-L503PTH	TA12S05-1003PTH	TA12S05-1503PTH	–	TA12S05-0103GC
	4.6	TA12S05-H346PTH	TA12S05-0546PTH	TA12S05-L546PTH	TA12S05-1046PTH	TA12S05-1546PTH	TA12S05-2546PTH	TA12S05-0104GC
<b>YMC-Triart Bio C18</b>	2.1	TA30S05-H3Q1PTH	TA30S05-05Q1PTH	TA30S05-L5Q1PTH	TA30S05-10Q1PTH	TA30S05-15Q1PTH	–	TA30S05-01Q1GC
	3.0	–	TA30S05-0503PTH	TA30S05-L503PTH	TA30S05-1003PTH	TA30S05-1503PTH	–	TA30S05-0103GC
	4.6	TA30S05-H346PTH	TA30S05-0546PTH	TA30S05-L546PTH	TA30S05-1046PTH	TA30S05-1546PTH	TA30S05-2546PTH	TA30S05-0104GC
<b>YMC-Triart C8</b>	2.1	T012S05-H3Q1PTH	T012S05-05Q1PTH	T012S05-L5Q1PTH	T012S05-10Q1PTH	T012S05-15Q1PTH	–	T012S05-01Q1GC
	3.0	–	T012S05-0503PTH	T012S05-L503PTH	T012S05-1003PTH	T012S05-1503PTH	–	T012S05-0103GC
	4.6	T012S05-H346PTH	T012S05-0546PTH	T012S05-L546PTH	T012S05-1046PTH	T012S05-1546PTH	T012S05-2546PTH	T012S05-0104GC
<b>YMC-Triart Bio C4</b>	2.1	TB30S05-H3Q1PTH	TB30S05-05Q1PTH	TB30S05-L5Q1PTH	TB30S05-10Q1PTH	TB30S05-15Q1PTH	–	TB30S05-01Q1GC
	3.0	–	TB30S05-0503PTH	TB30S05-L503PTH	TB30S05-1003PTH	TB30S05-1503PTH	–	TB30S05-0103GC
	4.6	TB30S05-H346PTH	TB30S05-0546PTH	TB30S05-L546PTH	TB30S05-1046PTH	TB30S05-1546PTH	TB30S05-2546PTH	TB30S05-0104GC
<b>Hydrosphere C18</b>	2.1	HS12S05-03Q1WT	HS12S05-05Q1WT	HS12S05-L5Q1WT	HS12S05-10Q1WT	HS12S05-15Q1WT	HS12S05-25Q1WT	HS12S05-01Q1GC
	3.0	HS12S05-0303WT	HS12S05-0503WT	HS12S05-L503WT	HS12S05-1003WT	HS12S05-1503WT	HS12S05-2503WT	HS12S05-0103GC
	4.6	HS12S05-0346WT	HS12S05-0546WT	HS12S05-L546WT	HS12S05-1046WT	HS12S05-1546WT	HS12S05-2546WT	HS12S05-0104GC
<b>YMCbasic (eq. C8)</b>	2.1	BA99S05-03Q1WT	BA99S05-05Q1WT	BA99S05-L5Q1WT	BA99S05-10Q1WT	BA99S05-15Q1WT	BA99S05-25Q1WT	BA99S05-01Q1GC
	3.0	BA99S05-0303WT	BA99S05-0503WT	BA99S05-L503WT	BA99S05-1003WT	BA99S05-1503WT	BA99S05-2503WT	BA99S05-0103GC
	4.6	BA99S05-0346WT	BA99S05-0546WT	BA99S05-L546WT	BA99S05-1046WT	BA99S05-1546WT	BA99S05-2546WT	BA99S05-0104GC

\*Guard cartridge holder required, part no. XPGCH-Q1

## RP – Ordering information

### 5 µm metal-free HPLC columns

Phase	Column ID [mm]	Column length [mm]		
		50	100	150
<b>YMC-Triart C18</b>	2.1	TA12S05-05Q1PTP	TA12S05-10Q1PTP	TA12S05-15Q1PTP
	4.6	TA12S05-0546PTP	TA12S05-1046PTP	TA12S05-1546PTP
<b>YMC-Triart Bio C18</b>	2.1	TA30S05-05Q1PTP	TA30S05-10Q1PTP	TA30S05-15Q1PTP
	4.6	TA30S05-0546PTP	TA30S05-1046PTP	TA30S05-1546PTP
<b>YMC-Triart C8</b>	2.1	T012S05-05Q1PTP	T012S05-10Q1PTP	T012S05-15Q1PTP
	4.6	T012S05-0546PTP	T012S05-1046PTP	T012S05-1546PTP
<b>YMC-Triart Bio C4</b>	2.1	TB30S05-05Q1PTP	TB30S05-10Q1PTP	TB30S05-15Q1PTP
	4.6	TB30S05-0546PTP	TB30S05-1046PTP	TB30S05-1546PTP

Special column connectors required.

### 5 µm YMC-Actus high-throughput semipreparative columns

Phase	Column ID [mm]	Column length [mm]					Guard cartridges* with 10 mm length (pack of 5)
		50	75	100	150	250	
<b>YMC-Triart C18</b>	20	TA12S05-0520WX	TA12S05-L520WX	TA12S05-1020WX	TA12S05-1520WX	TA12S05-2520WX	TA12S05-0120CCN
	30	TA12S05-0530WX	TA12S05-L530WX	TA12S05-1030WX	TA12S05-1530WX	TA12S05-2530WX	TA12S05-0130CCN
	50	TA12S05-0553DX	–	TA12S05-1053DX	TA12S05-1553DX	TA12S05-2553DX	TA12S05-0553DXG**
<b>YMC-Triart Bio C18</b>	20	TA30S05-0520WX	TA30S05-L520WX	TA30S05-1020WX	TA30S05-1520WX	TA30S05-2520WX	TA30S05-0120CCN
	30	TA30S05-0530WX	TA30S05-L530WX	TA30S05-1030WX	TA30S05-1530WX	TA30S05-2530WX	TA30S05-0130CCN
	50	TA30S05-0553DX	–	TA30S05-1053DX	TA30S05-1553DX	TA30S05-2553DX	TA30S05-0553DXG**
<b>YMC-Triart C8</b>	20	T012S05-0520WX	T012S05-L520WX	T012S05-1020WX	T012S05-1520WX	T012S05-2520WX	T012S05-0120CCN
	30	T012S05-0530WX	T012S05-L530WX	T012S05-1030WX	T012S05-1530WX	T012S05-2530WX	T012S05-0130CCN
	50	T012S05-0553DX	–	T012S05-1053DX	T012S05-1553DX	T012S05-2553DX	T012S05-0553DXG**
<b>YMC-Triart Bio C4</b>	20	TB30S05-0520WX	TB30S05-L520WX	TB30S05-1020WX	TB30S05-1520WX	TB30S05-2520WX	TB30S05-0120CCN
	30	TB30S05-0530WX	TB30S05-L530WX	TB30S05-1030WX	TB30S05-1530WX	TB30S05-2530WX	TB30S05-0130CCN
	50	TB30S05-0553DX	–	TB30S05-1053DX	TB30S05-1553DX	TB30S05-2553DX	TB30S05-0553DXG**
<b>Hydrosphere C18</b>	20	HS12S05-0520WX	HS12S05-L520WX	HS12S05-1020WX	HS12S05-1520WX	HS12S05-2520WX	HS12S05-0120CCN
	30	HS12S05-0530WX	HS12S05-L530WX	HS12S05-1030WX	HS12S05-1530WX	HS12S05-2530WX	HS12S05-0130CCN
	50	HS12S05-0553DX	–	HS12S05-1053DX	HS12S05-1553DX	HS12S05-2553DX	–
<b>YMCbasic (eq. C8)</b>	20	BA99S05-0520WX	BA99S05-L520WX	BA99S05-1020WX	BA99S05-1520WX	BA99S05-2520WX	BA99S05-0120CCN
	30	BA99S05-0530WX	BA99S05-L530WX	BA99S05-1030WX	BA99S05-1530WX	BA99S05-2530WX	BA99S05-0130CCN
	50	BA99S05-0553DX	–	BA99S05-1053DX	BA99S05-1553DX	BA99S05-2553DX	–

\*Guard cartridge holder required, part no. XPGHF2P20ID (20 mm ID)  
XPGHF2P30ID (30 mm ID)  
no holder required for 50 mm





SEC

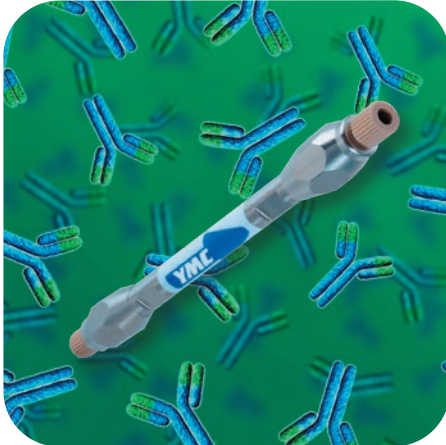

## SEC – UHPLC / HPLC Selectivities

- **Applicable to proteins, antibodies, their fragments and peptides**
- **Also applicable to carbohydrates and nucleic acid components**
- **Excellent reproducibility with minimal secondary interactions**
- **2 µm for UHPLC**
- **Cost effective**

	YMC-Pack Diol-60	YMC-Pack Diol-120	YMC-Pack Diol-200	YMC-Pack Diol-300	YMC-SEC MAB
	For peptides and small proteins	For intermediate proteins	For large proteins	For very large proteins	For antibodies, fragments and aggregates
<b>Base particle</b>	Silica				
<b>Particle Size / µm</b>	3, 5	3, 5	2, 3, 5	2, 3, 5	3
<b>Pore Size / nm</b>	6	12	20	30	25
<b>Modification</b>	Dihydroxypropyl				
<b>Temperature range</b>	40 °C				
<b>Pressure limit</b>	2 µm: 45 MPa (6,525 psi); 3/5 µm: 20 MPa (3,000 psi)				14 MPa (2,030 psi)

“

*“The YMC-Pack Diol SEC column has been successfully used for subsequent method validation.”*

*Rubén Pedrosa Segon, Head of Quality Control Pharmaceutical Department, OFICE S.L. (ES)*

”

### Column Selection Tool

for MW < 10,000

● YMC-Pack Diol-60

for MW 1,000 to 100,000

● YMC-Pack Diol-120

for MW 5,000 to 300,000

● YMC-Pack Diol-200

for MW 10,000 to 700,000

● YMC-SEC MAB

for MW 20,000 to 1,000,000

● YMC-Pack Diol-300

# SEC – YMC-Pack Diol: Phase selection for proteins

## Phases for different MW ranges

For separation of proteins with molecular weights from 10,000 to several 100,000 Da

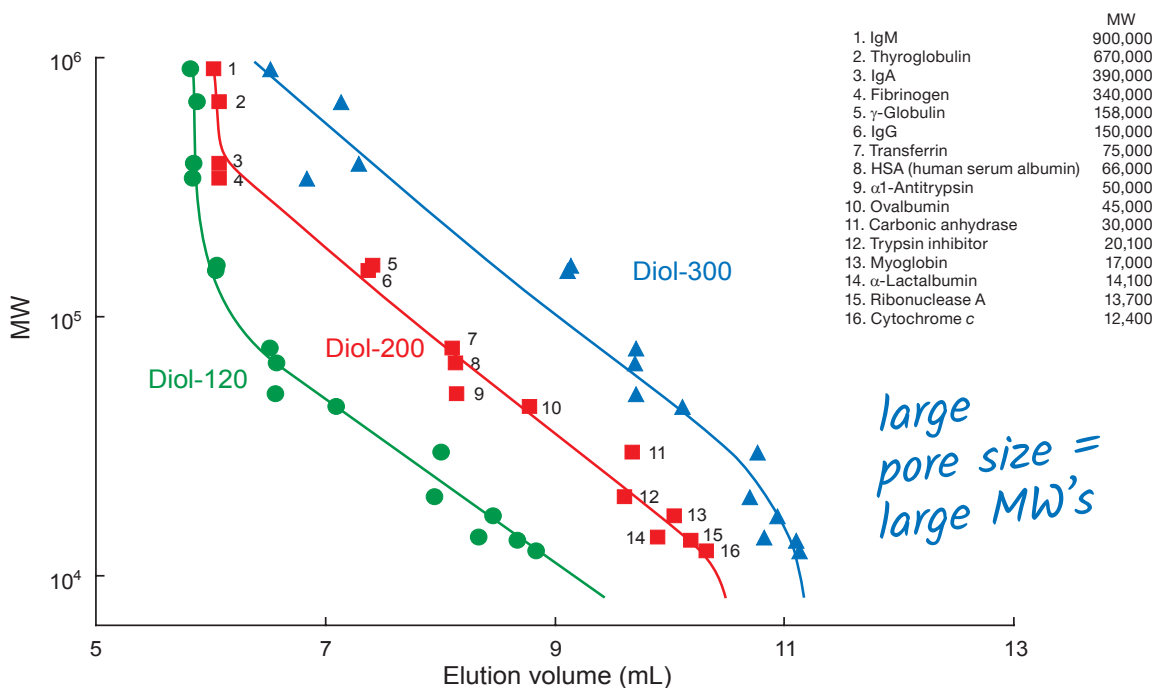

Column: YMC-Pack Diol, 300 x 8.0 mm ID  
 Part Nos.: DL12S05-3008WT, DL20S05-3008WT, DL30S05-5008WT  
 Eluent: 0.1 M  $\text{KH}_2\text{PO}_4$ - $\text{K}_2\text{HPO}_4$  (pH 7.0) containing 0.2 M NaCl  
 Flow rate: 0.5 mL/min  
 Temperature: 25 °C  
 Detection: UV at 280 nm

For molecular weight determination of oligosaccharides and polysaccharides

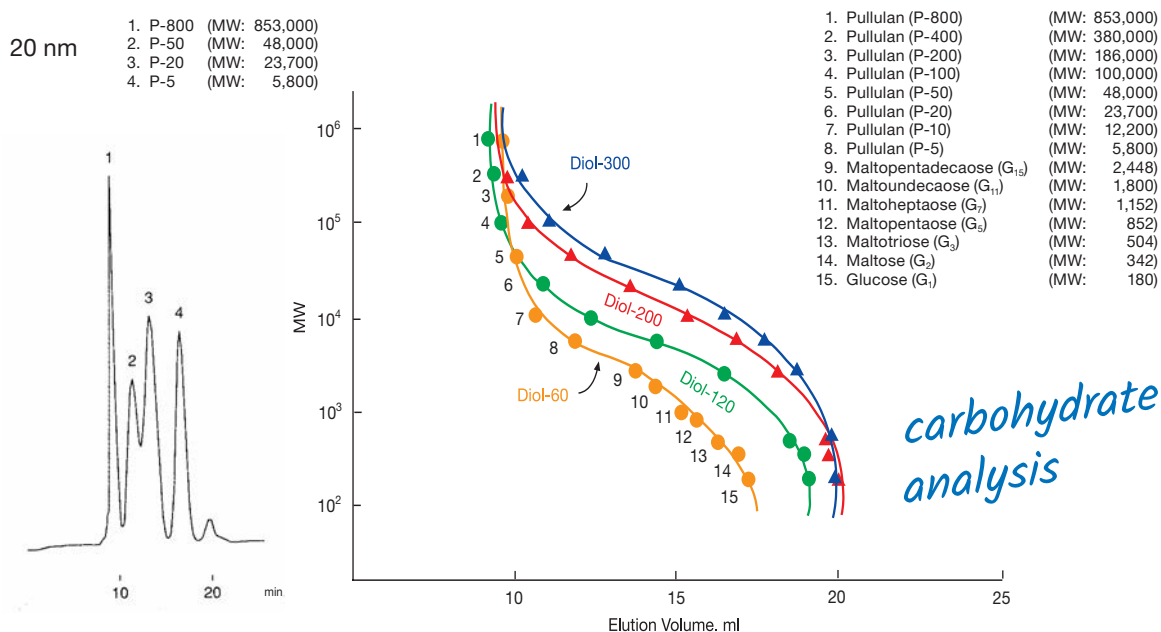

Column: YMC-Pack Diol (20 nm) 500 x 8.0 mm ID  
 Part No.: DL20S05-5008WT  
 Eluent: water  
 Flow rate: 1.0 mL/min  
 Temperature: ambient  
 Detection: RI

## Ideal choice for monoclonal antibodies

### Bevacizumab and its fragments and aggregates

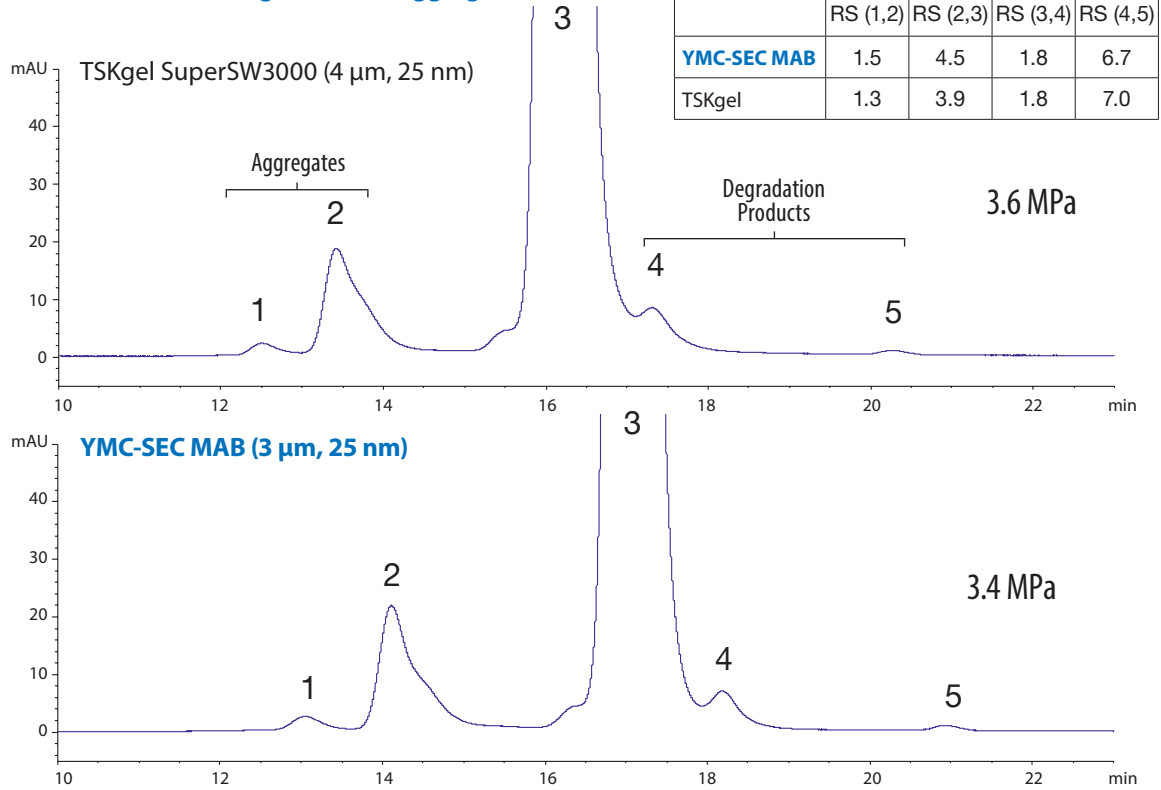

Column: 300 x 4.6 mm ID  
 Part No.: DLM25S03-3046WT  
 Eluent: 0.1 M phosphate buffer (pH = 7) cont. 0.2 M NaCl  
 Flow rate: 0.165 mL/min  
 Temperature: 25 °C

Detection: UV at 280 nm  
 Cell path: 10 mm  
 Injection: 10 µL (5 mg/mL)  
 Sample: Bevacizumab (Avastin®)

### Suitable for Antibody-Drug-Conjugates (ADCs)

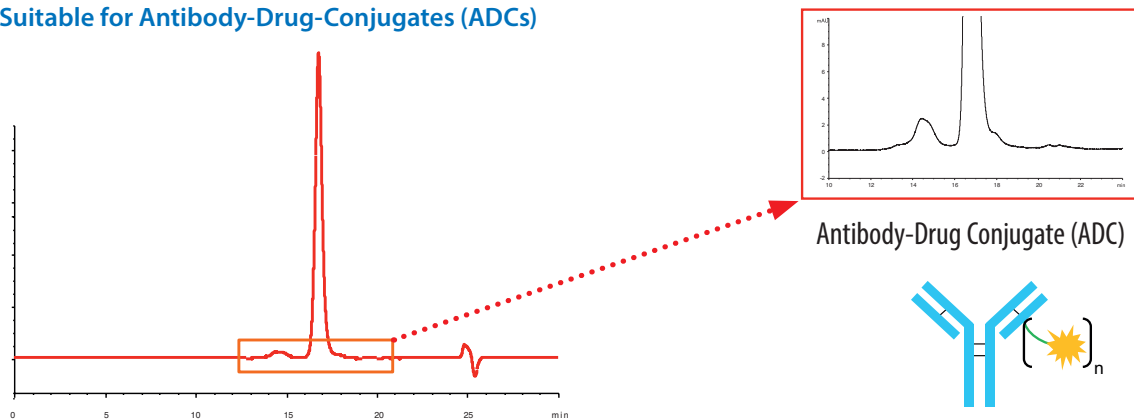

Column: YMC-SEC MAB (3 µm, 25 nm) 300 x 4.6 mm ID  
 Part No.: DLM25S03-3046WT  
 Eluent: 0.1 M phosphate buffer (pH = 7) cont. 0.2 M NaCl /  
 2-propanol (85 / 15)  
 Flow rate: 0.165 mL/min

Temperature: 25 °C  
 Detection: UV at 280 nm  
 Injection: 4 µL (2.5 mg/mL)  
 Sample: SigmaMAb Antibody Drug Conjugate Mimic

**YMC-SEC MAB is also suitable for the analysis of Antibody-Drug Conjugates (ADC). The addition of an organic solvent to the mobile phase can improve the results obtained for ADC analysis.**

# SEC – YMC-SEC MAB: MALLS

## YMC-SEC columns ideally combined with light scattering detection

### Detection of higher molar mass species by MALLS

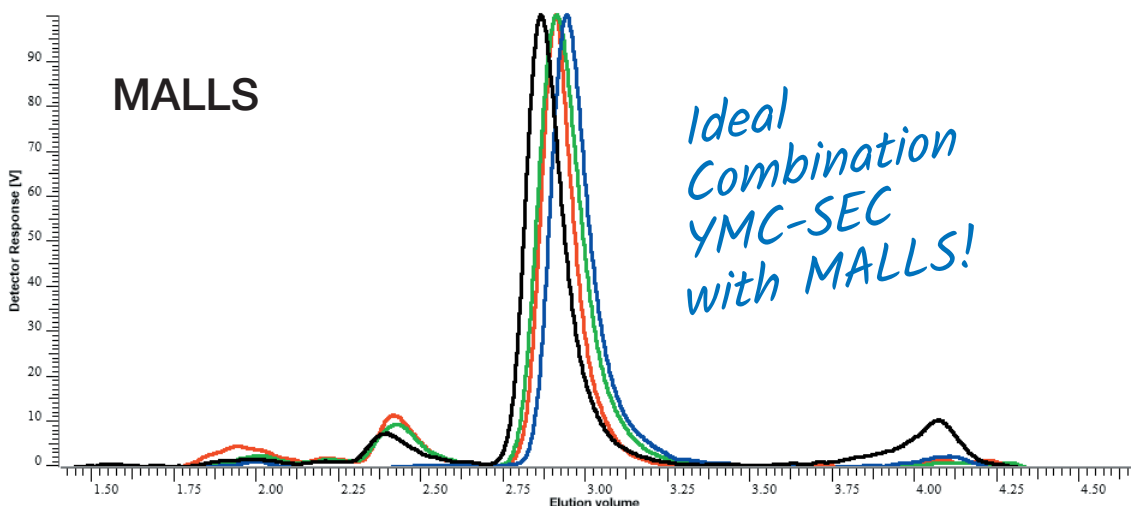
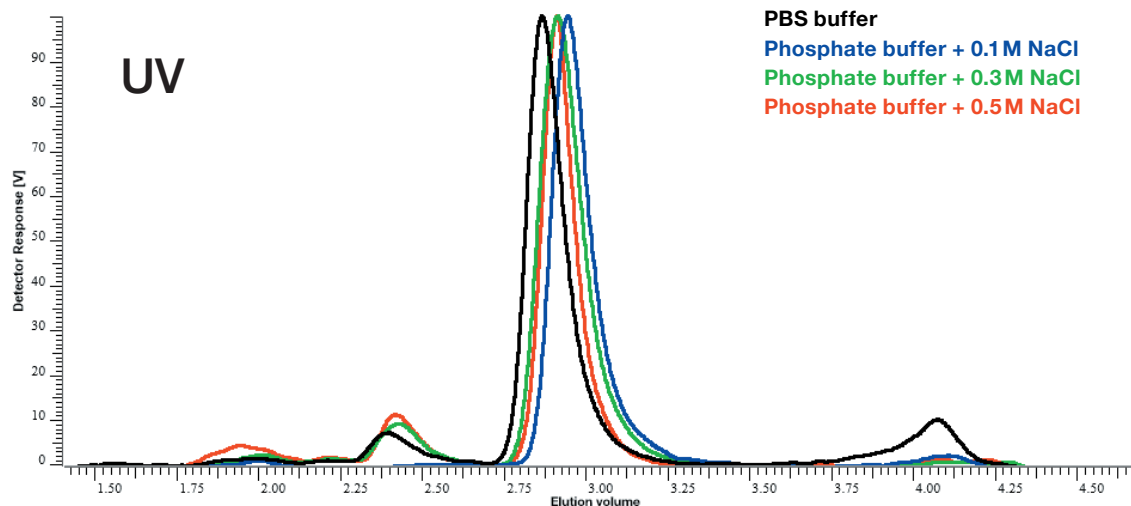

Column: YMC-SEC MAB (3  $\mu$ m, 25 nm) 300 x 4.6 mm ID  
 Part No.: DLM25S03-3046WT  
 Eluent: Phosphate buffer pH 6.6 containing 0.3 M NaCl  
 Flow rate: 0.33 mL/min  
 Temperature: 25 °C  
 Detection: MALLS at 90° angle (PSS SLD7100), UV at 280 nm  
 Injection volume: 10  $\mu$ L  
 Sample: Bevacizumab (Avastin®) dosage form (10 mg/mL, diluted to 1 mg/mL)  
 System: PSS-SECcurity GPC systems, 1260 Infinity II  
 Software: WinGPC Unichrom

Courtesy of Thorsten Hofe, PSS Polymer Standards Service GmbH, Mainz, Germany.

Four different buffers, a phosphate buffered saline (PBS) pH 7.4 and phosphate buffers pH 6.6 with varying concentrations of NaCl, were used to develop a suitable MALLS detection method for MABs.

A defined minimum ionic strength is necessary to achieve a robust method with good resolution. The phosphate buffer with 0.3 M NaCl appeared to be the most suitable eluent.

Compared to UV detection, the MALLS signal shows 2 higher molar mass species, aggregates of Bevacizumab, at about 2.0 mL and 2.3 mL elution volume.

# SEC – YMC-SEC MAB: Reproducibility & stability

## Excellent lot-to-lot reproducibility

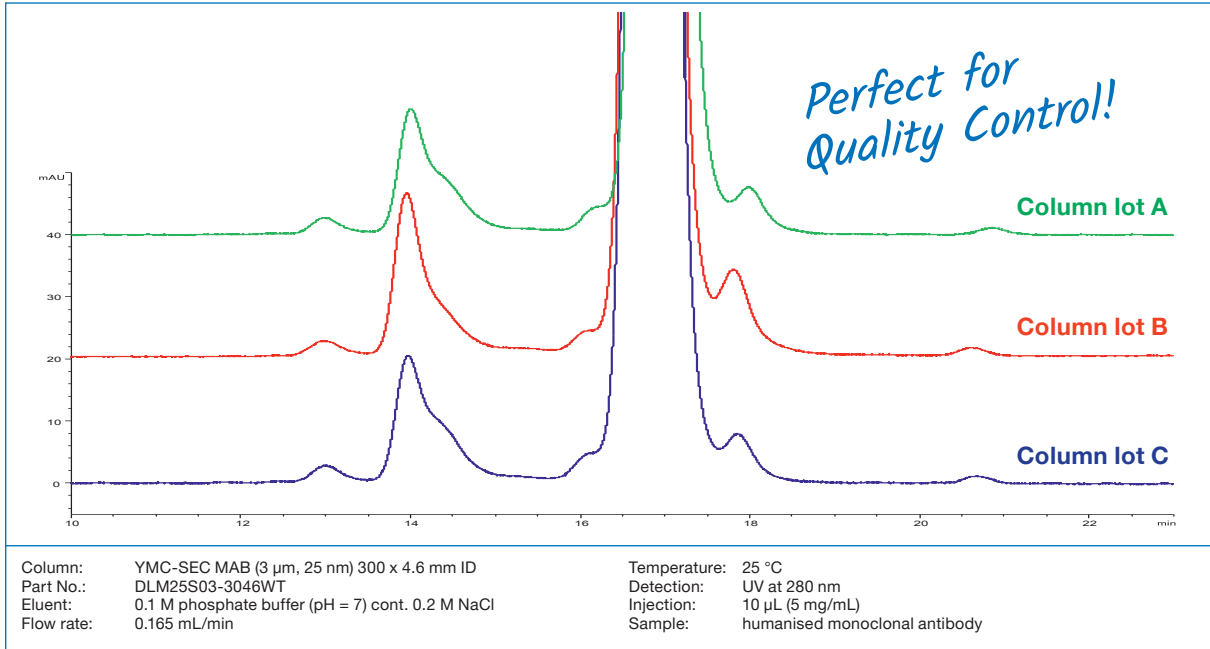

YMC-SEC MAB provides excellent reproducibility for the separation of monomer and aggregates as well as for monomer and their fragments, making it very effective for quality control of antibody drugs.

## High column stability

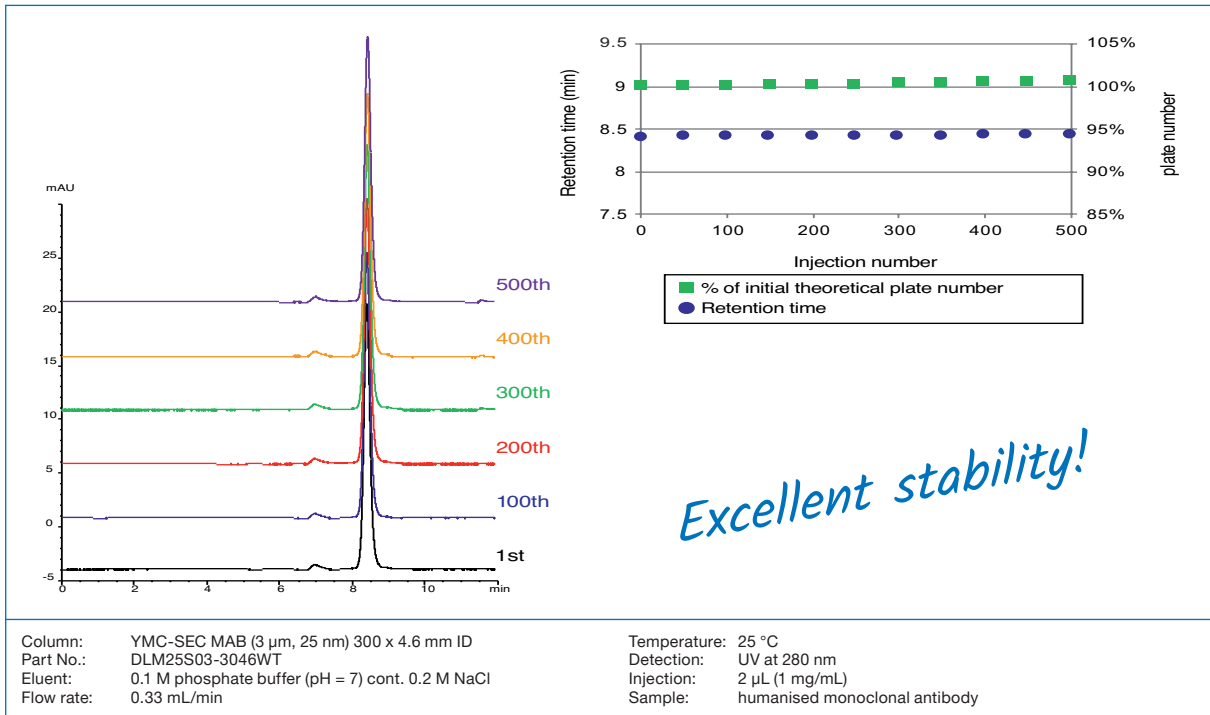

Excellent stability is provided for monoclonal antibody analysis without any changes in theoretical plate number or elution time even after more than 500 injections.

# SEC – YMC-Pack Diol: Resolution & throughput

## Benefits of using smaller particles

### Higher resolution for analysis of monoclonal antibodies

(A) YMC-Pack Diol-300 (2  $\mu\text{m}$ )  
300 x 4.6 mm ID

(B) YMC-Pack Diol-300 (3  $\mu\text{m}$ )  
300 x 4.6 mm ID

(C) YMC-Pack Diol-300 (5  $\mu\text{m}$ )  
300 x 4.6 mm ID

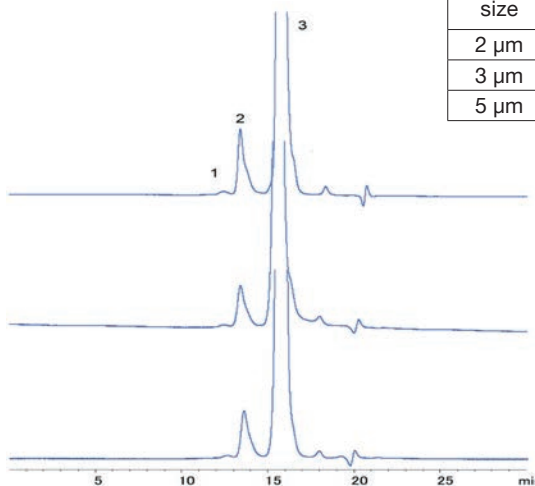

Particle size	Rs (1,2)	Rs (2,3)	N (3)
2 $\mu\text{m}$	1.17	4.15	16,200
3 $\mu\text{m}$	1.03	3.18	10,400
5 $\mu\text{m}$	0.88	2.67	<b>8,500</b>

Columns: YMC-Pack Diol-300, 300 x 4.6 mm ID  
Part Nos.: (A) DL30S02-3046PTH  
(B) DL30S03-3046WT  
(C) DL30S05-3046WT  
Eluent: 0.1 M  $\text{KH}_2\text{PO}_4$ - $\text{K}_2\text{HPO}_4$  (pH 7.0) containing 0.2 M NaCl

Flow rate: 0.2 mL/min  
Temperature: ambient  
Detection: UV at 280 nm  
Sample: Humanised monoclonal antibody (IgG1)

All three particle sizes show identical separation patterns for monoclonal antibody analysis. This allows easy method transfer between HPLC and UHPLC. A method developed using conventional HPLC can be directly transferred to UHPLC using a 2  $\mu\text{m}$  YMC-Pack Diol

column. YMC-Pack Diol UHPLC columns greatly improve the resolution between aggregates and the monomer peak. In addition, a shoulder peak which can be observed after the monomer peak can be partially separated using the 2  $\mu\text{m}$  column.

### High throughput analysis of monoclonal antibodies

YMC-Pack Diol-300 (2  $\mu\text{m}$ )  
300 x 4.6 mm ID

YMC-Pack Diol-300 (2  $\mu\text{m}$ )  
150 x 4.6 mm ID

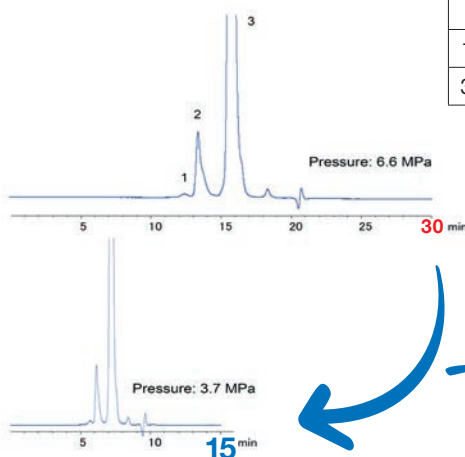

Column length	Rs (1,2)	Rs (2,3)	N (3)
150 mm	0.85	2.75	8,700
300 mm	1.17	4.15	16,200

Columns: YMC-Pack Diol-300, 150 or 300 x 4.6 mm ID  
Part Nos.: DL30S02-3046PTH / DL30S02-1546PTH  
Eluent: 0.1 M  $\text{KH}_2\text{PO}_4$ - $\text{K}_2\text{HPO}_4$  (pH 7.0) containing 0.2 M NaCl  
Flow rate: 0.2 mL/min

Temperature: ambient  
Detection: UV at 280 nm  
Sample: Humanised monoclonal antibody (IgG1)

By using a 150 mm length column, 50% shorter run times can be achieved with the same resolution as for a 300 mm length column (compare upper and lower chromatograms). This allows an increase in throughput to be achieved. The backpressure is only 6.6 MPa, even for the 300 mm column. Therefore, YMC-Pack Diol 2  $\mu\text{m}$  columns can be used with both UHPLC and HPLC systems.



# SEC – YMC-Pack Diol: Reproducibility & stability

## Reproducibility and stability data

### Excellent batch-to-batch reproducibility

#### Standard proteins

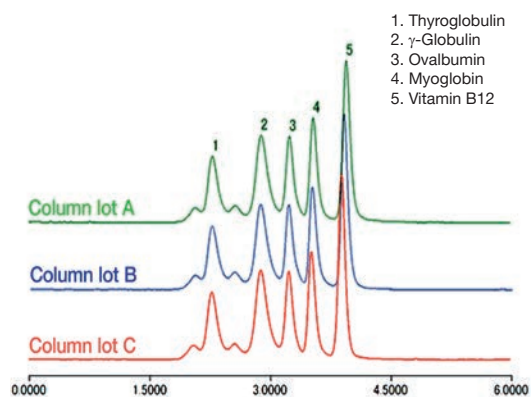

Column: YMC-Pack Diol-300 (2 μm) 150 x 4.6 mm ID  
 Part No.: DL30S02-1546PTH  
 Eluent: 0.1 M NaH<sub>2</sub>PO<sub>4</sub>-Na<sub>2</sub>HPO<sub>4</sub> (pH 7.0) containing 0.2 M NaCl  
 Flow rate: 0.5 mL/min  
 Temperature: ambient  
 Detection: UV at 280 nm  
 Sample: Standard proteins

#### Humanised monoclonal antibody

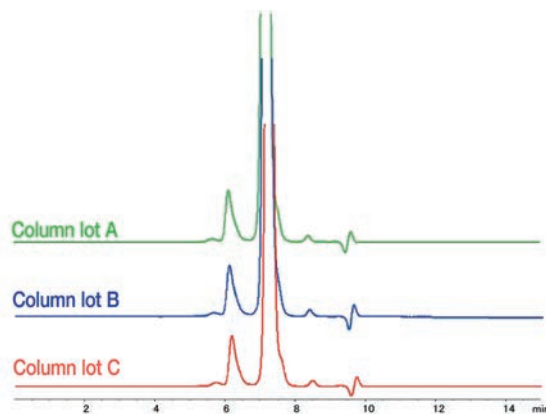

Column: YMC-Pack Diol-300 (2 μm) 150 x 4.6 mm ID  
 Part No.: DL30S02-1546PTH  
 Eluent: 0.1 M KH<sub>2</sub>PO<sub>4</sub>-K<sub>2</sub>HPO<sub>4</sub> (pH 7.0) containing 0.2 M NaCl  
 Flow rate: 0.2 mL/min  
 Temperature: 25 °C  
 Detection: UV at 280 nm  
 Sample: Humanised monoclonal antibody

YMC-Pack Diol UHPLC columns have excellent batch-to-batch reproducibility. This makes YMC-Pack Diol 2 μm columns the ideal choice for the quality control of bio-based drugs including monoclonal antibodies.

### Long-term stability

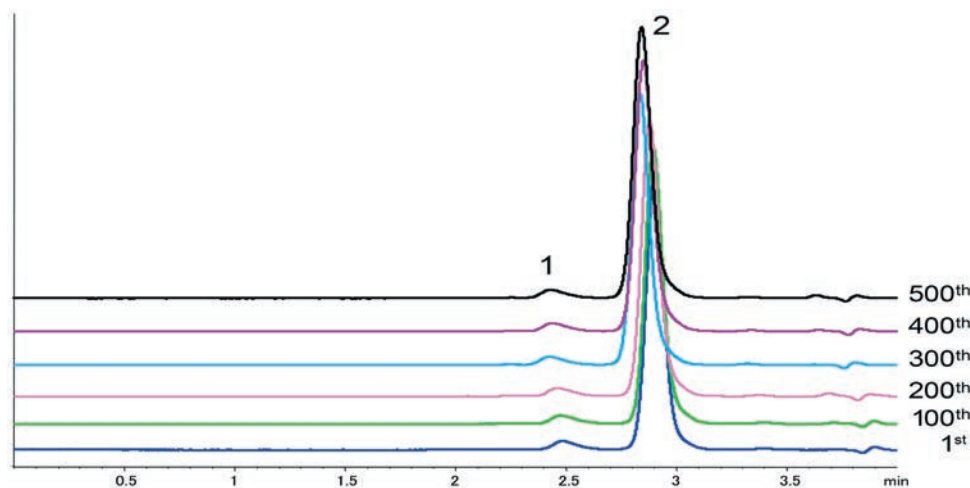

Column: YMC-Pack Diol-300 (2 μm) 150 x 4.6 mm ID  
 Part No.: DL30S02-1546PTH  
 Eluent: 0.1 M KH<sub>2</sub>PO<sub>4</sub>-K<sub>2</sub>HPO<sub>4</sub> (pH 7.0) containing 0.2 M NaCl  
 Flow rate: 0.5 mL/min

Temperature: 25 °C  
 Detection: UV at 280 nm  
 Sample: Humanised monoclonal antibody

YMC-Pack Diol UHPLC columns maintain their performance for more than 500 injections of sample during monoclonal antibody analysis. This ensures reproducible and reliable quality control of bio-based drugs including monoclonal antibodies.

## SEC – Ordering information

### 2 µm UHPLC columns

Phase	Column ID [mm]	Column length [mm]		Guard cartridges* with 10 mm length (pack of 5)
		150	300	
YMC-Pack Diol-200	4.6	DL20S02-1546PTH	DL20S02-3046PTH	DL20S02-0104GC
YMC-Pack Diol-300	4.6	DL30S02-1546PTH	DL30S02-3046PTH	DL30S02-0104GC

\*Guard cartridge holder required, part no. XPGCH-Q1

### 3 µm HPLC columns

Phase	Column ID [mm]	Column length [mm]			Guard cartridges* with 10/30 mm length (pack of 5)
		150	250	300	
YMC-SEC MAB	4.6	DLM25S03-1546WT	–	DLM25S03-3046WT	DLM25S03-0104GC
	6.0	–	–	–	–
	8.0	–	–	DLM25S03-3008WT	–
YMC-Pack Diol-60	4.6	DL06S03-1546WT	DL06S03-2546WT	DL06S03-3046WT	DL06S03-0104GC
	6.0	–	–	DL06S03-3006WT	–
	8.0	DL06S03-1508WT	–	DL06S03-3008WT	DL06S03-0308WTG**
YMC-Pack Diol-120	4.6	DL12S03-1546WT	DL12S03-2546WT	DL12S03-3046WT	DL12S03-0104GC
	6.0	–	–	DL12S03-3006WT	–
	8.0	DL12S03-1508WT	–	DL12S03-3008WT	DL12S03-0308WTG**
YMC-Pack Diol-200	4.6	DL20S03-1546WT	DL20S03-2546WT	DL20S03-3046WT	DL20S03-0104GC
	6.0	–	–	DL20S03-3006WT	–
	8.0	DL20S03-1508WT	–	DL20S03-3008WT	DL20S03-0308WTG**
YMC-Pack Diol-300	4.6	DL30S03-1546WT	DL30S03-2546WT	DL30S03-3046WT	DL30S03-0104GC
	6.0	–	–	DL30S03-3006WT	–
	8.0	DL30S03-1508WT	–	DL30S03-3008WT	DL30S03-0308WTG**

\*Guard cartridge holder required, part no. XPGCH-Q1

\*\*no holder required for 30 x 8 mm ID guards

### 5 µm HPLC columns

Phase	Column ID [mm]	Column length [mm]			Guard cartridges* with 10/30 mm length (pack of 5)
		250	300	500	
YMC-Pack Diol-60	4.6	DL06S05-2546WT	DL06S05-3046WT	–	DL06S05-0104GC
	6.0	DL06S05-2506WT	DL06S05-3006WT	DL06S05-5006WT	–
	8.0	–	DL06S05-3008WT	DL06S05-5008WT	DL06S05-0308WTG**
	10.0	DL06S05-2510WT	DL06S05-3010WT	DL06S05-5010WT	DL06S05-0310WTG**
YMC-Pack Diol-120	4.6	DL12S05-2546WT	DL12S05-3046WT	–	DL12S05-0104GC
	6.0	DL12S05-2506WT	DL12S05-3006WT	DL12S05-5006WT	–
	8.0	–	DL12S05-3008WT	DL12S05-5008WT	DL12S05-0308WTG**
	10.0	DL12S05-2510WT	DL12S05-3010WT	DL12S05-5010WT	DL12S05-0310WTG**
YMC-Pack Diol-200	4.6	DL20S05-2546WT	DL20S05-3046WT	–	DL20S05-0104GC
	6.0	DL20S05-2506WT	DL20S05-3006WT	DL20S05-5006WT	–
	8.0	–	DL20S05-3008WT	DL20S05-5008WT	DL20S05-0308WTG**
	10.0	DL20S05-2510WT	DL20S05-3010WT	DL20S05-5010WT	DL20S05-0310WTG**
YMC-Pack Diol-300	4.6	DL30S05-2546WT	DL30S05-3046WT	–	DL30S05-0104GC
	6.0	DL30S05-2506WT	DL30S05-3006WT	DL30S05-5006WT	–
	8.0	–	DL30S05-3008WT	DL30S05-5008WT	DL30S05-0308WTG**
	10.0	DL30S05-2510WT	DL30S05-3010WT	DL30S05-5010WT	DL30S05-0310WTG**

\*Guard cartridge holder required, part no. XPGCH-Q1

\*\*no holder required for 30 x 8/10 mm ID guards



IEX

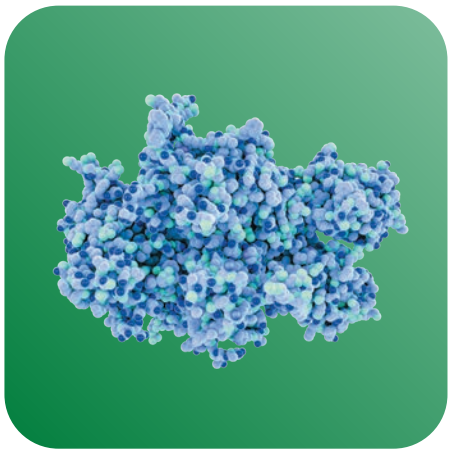

# IEX – Bio Pro Series

- porous or non-porous hydrophilic polymers
- high binding capacity and recovery of biomolecules
- very high resolution
- low nonspecific adsorption
- excellent reproducibility

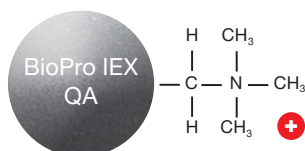

strong anion exchanger

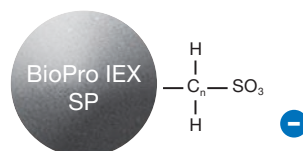

strong cation exchanger

	BioPro IEX QA	BioPro IEX SP
Matrix	hydrophilic polymer (polymethacrylate)	hydrophilic polymer (polymethacrylate)
Particle size / $\mu\text{m}$	5	5
Pore size / nm	100	100
Charged group	$-\text{CH}_2\text{N}^+(\text{CH}_3)_3$	$-(\text{CH}_2)_3\text{SO}_3^-$
Counter ion	$\text{Cl}^-$	$\text{Na}^+$
Available pH range	2.0–12.0	2.0–12.0
Temperature range	4–60 °C	
Pressure limit	2.5–3.5 MPa (360–510 psi)	
Column hardware	PEEK	

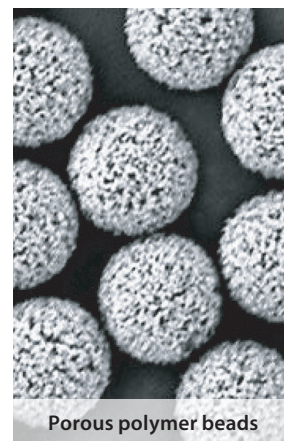

Porous polymer beads

Also available in 10, 20, 30 or 75  $\mu\text{m}$  for preparative scale

	BioPro IEX QF	BioPro IEX SF
Matrix	hydrophilic polymer (polymethacrylate)	hydrophilic polymer (polymethacrylate)
Particle size / $\mu\text{m}$	3, 5	3, 5
Pore size / nm	non-porous	non-porous
Charged group	$-\text{CH}_2\text{N}^+(\text{CH}_3)_3$	$-(\text{CH}_2)_3\text{SO}_3^-$
Counter ion	$\text{Cl}^-$	$\text{Na}^+$
Available pH range	2.0–12.0	2.0–2.0
Temperature range	4–60 °C	
Pressure limit	3 $\mu\text{m}$ : 25 MPa (3,625 psi) 5 $\mu\text{m}$ : 6–12 MPa (870–1,740 psi)	
Column hardware	PEEK	

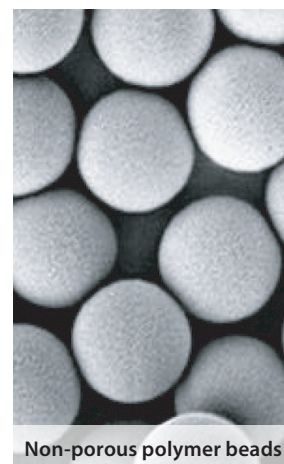

Non-porous polymer beads

YMC's BioPro IEX series of ion exchange columns are available in QA and SP chemistries, based on 5  $\mu\text{m}$  porous (QA or SP columns) or on 3 or 5  $\mu\text{m}$  non-porous (QF and SF columns) hydrophilic polymer beads.

The porous materials offer excellent binding capacity with exceptionally high efficiency and low operating pressure, whilst the non-porous particles offer high efficiency, very high resolution and low operating pressures.

# IEX – BioPro IEX: Reproducibility & DBC

## High binding capacity and high recovery for porous type

The porous versions of YMC's BioPro IEX show high dynamic binding capacity and excellent recovery, making them useful for semi-preparative separations of proteins and antibodies.

## Comparison of dynamic binding capacity (DBC) for BSA

	Dynamic binding capacity (mg/mL-gel, 10% breakthrough)	Eluted amount (mg/mL-gel)	Recovery* (%)
BioPro IEX QA	126	120	95
Mono Q (GE Healthcare)	100	35	35
BioAssist Q (Tosoh Bioscience)	73	58	79

*High recovery rates for BioPro IEX*

\* Recovery: (Eluted amount/Dynamic binding capacity) x 100

Compared with conventional porous polymer anion exchange columns, BioPro IEX QA provides higher DBC and recovery rates. This indicates that BioPro IEX has a much lower nonspecific adsorption compared to conventional columns.

## Excellent batch-to-batch reproducibility

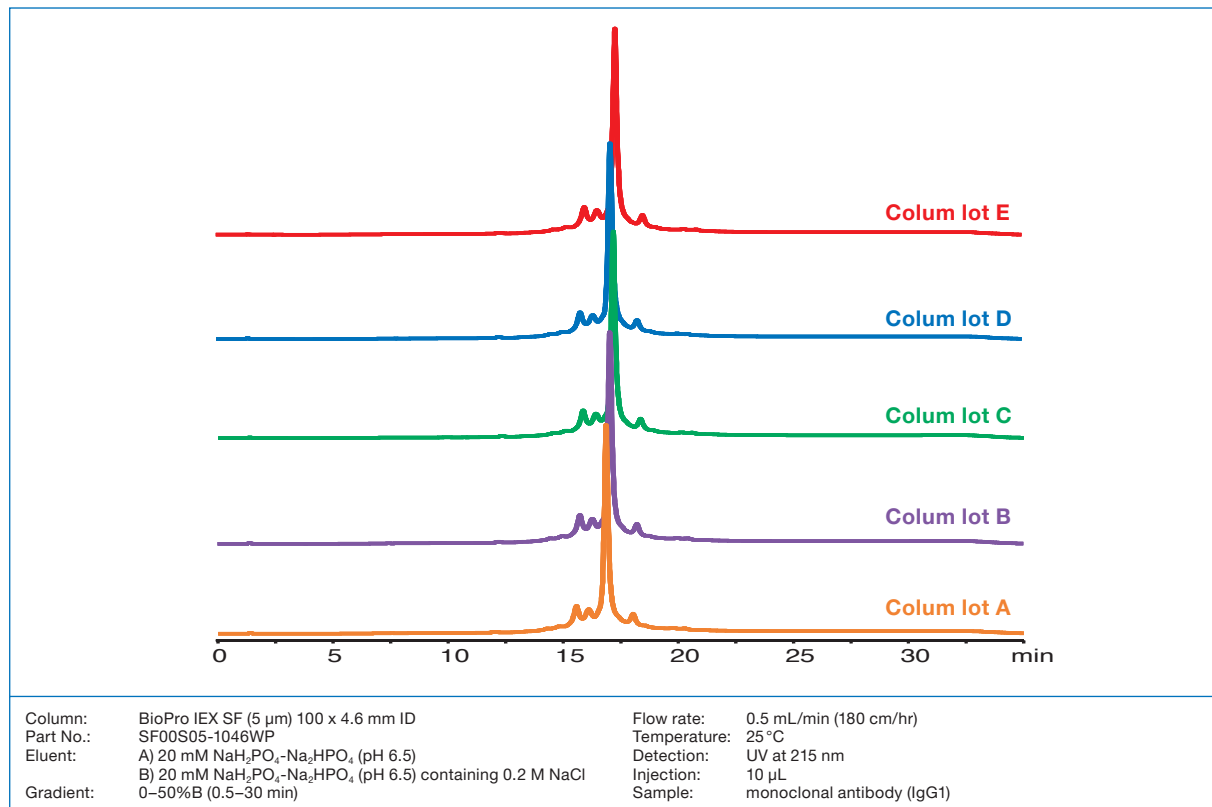

BioPro IEX SF columns exhibit excellent batch-to-batch reproducibility for MAb analysis with resolution of peaks for small charge variants. All gel batches are inspected by rigorous quality control tests, including HPLC analysis of MAb, and must meet the required criteria before release.

BioPro IEX columns are the best choice for the quality control of MAb and other biopharmaceuticals.

# IEX – BioPro IEX: Resolution & throughput

## Superior resolution

Comparison of standard protein separation on BioPro IEX SP and commercial S type products

**BioPro IEX SP, 5 µm**

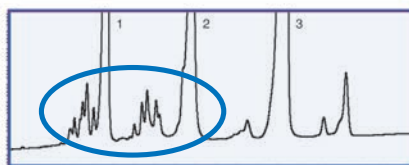
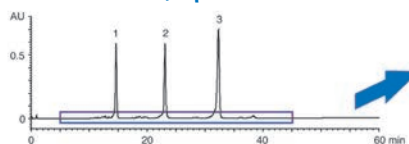

*Superior resolution*

**TSKgel BioAssist S, 7 µm**

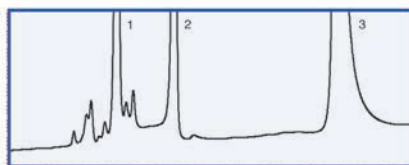
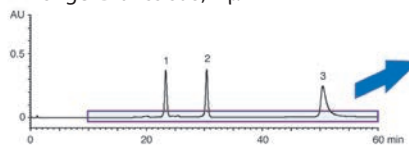

**GE Healthcare Mono S, 10 µm**

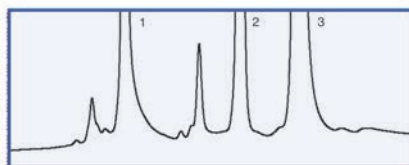
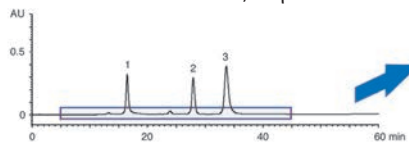

Eluent: A) 20 mM  $\text{KH}_2\text{PO}_4$ - $\text{K}_2\text{HPO}_4$  (pH 6.8)  
 B) 20 mM  $\text{KH}_2\text{PO}_4$ - $\text{K}_2\text{HPO}_4$  (pH 6.8) containing 0.5 M NaCl  
 Gradient: 0–100%B (0–60 min)  
 Flow rate: BioPro IEX SP, TSKgel BioAssist S 0.5 mL/min  
 GE Healthcare Mono S 0.59 mL/min  
 Temperature: 25 °C

Detection: UV at 220 nm  
 Injection: BioPro IEX SP, TSKgel BioAssist S 20 µL  
 GE Healthcare Mono S 23.6 µL  
 Sample: 1. Ribonuclease A (0.5 mg/mL)  
 2. Cytochrome c (0.5 mg/mL)  
 3. Lysozyme (0.5 mg/mL)

Only BioPro IEX is available in the smaller particle size and is therefore able to provide superior resolution.

## Ultra-high-throughput analysis with non-porous BioPro IEX

**Non-porous type  
 BioPro IEX SF (5 µm) 30 x 4.6 mm ID**

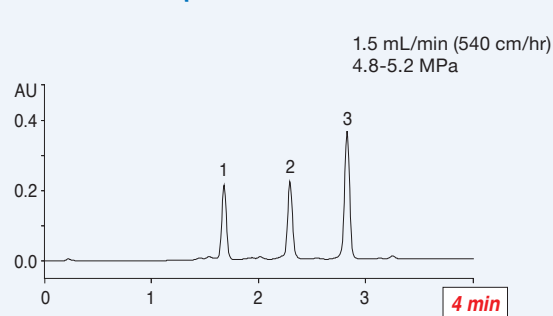

**Porous type  
 BioPro IEX SP (5 µm) 50 x 4.6 mm ID**

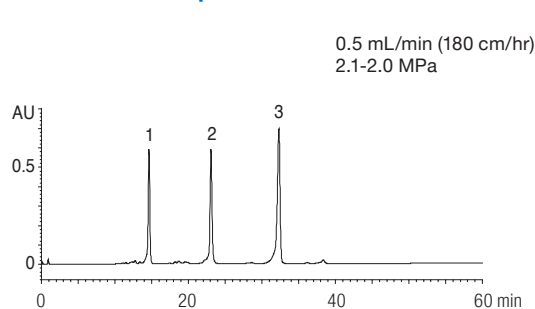

Eluent: A) 20 mM  $\text{KH}_2\text{PO}_4$ - $\text{K}_2\text{HPO}_4$  (pH 6.8)  
 B) 20 mM  $\text{KH}_2\text{PO}_4$ - $\text{K}_2\text{HPO}_4$  (pH 6.8) containing 0.5 M NaCl  
 Part Nos.: SF00S05-0346WP (non-porous)  
 SPA0S05-0546WP (porous)  
 Gradient: 0–100%B (0–4 min) for BioPro IEX SF  
 0–100%B (0–60 min) for BioPro IEX SP

Temperature: 25 °C  
 Detection: UV at 220 nm  
 Injection: 20 µL  
 Sample: 1. Ribonuclease A (0.5 mg/mL)  
 2. Cytochrome c (0.5 mg/mL)  
 3. Lysozyme (0.5 mg/mL)

The high mechanical stability of non-porous polymer beads and the short column length allow faster elution of proteins at a higher flow rate without any loss of resolution.

## Column efficiency and loadability

When to use porous and non-porous BioPro IEX

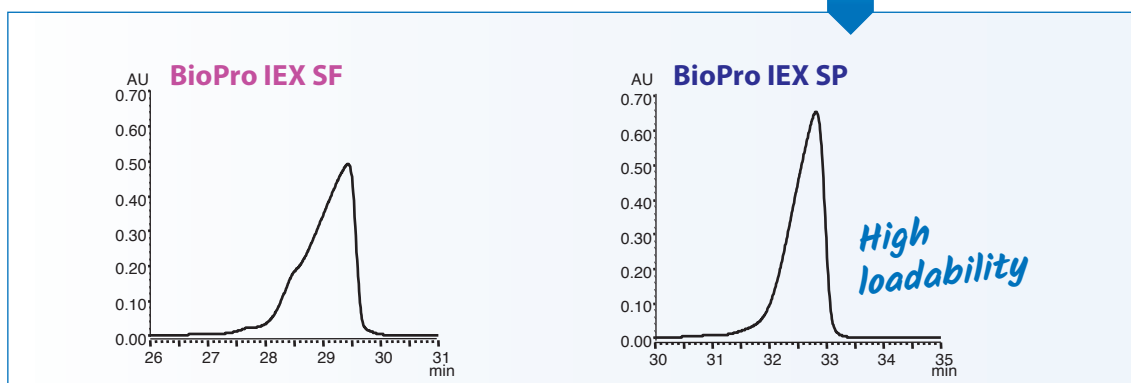
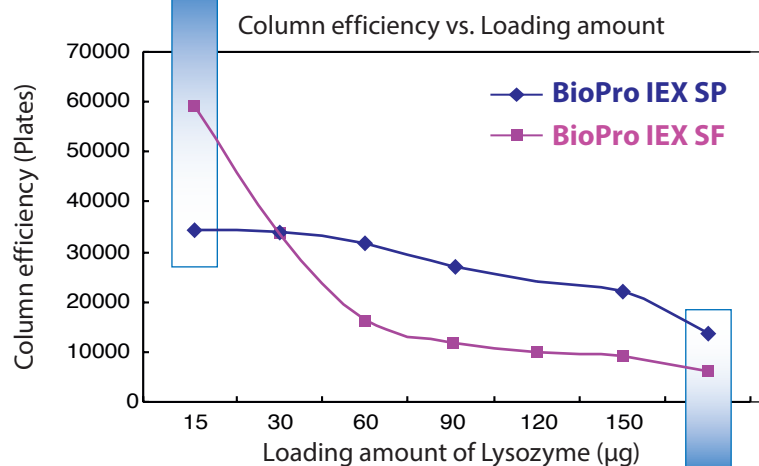
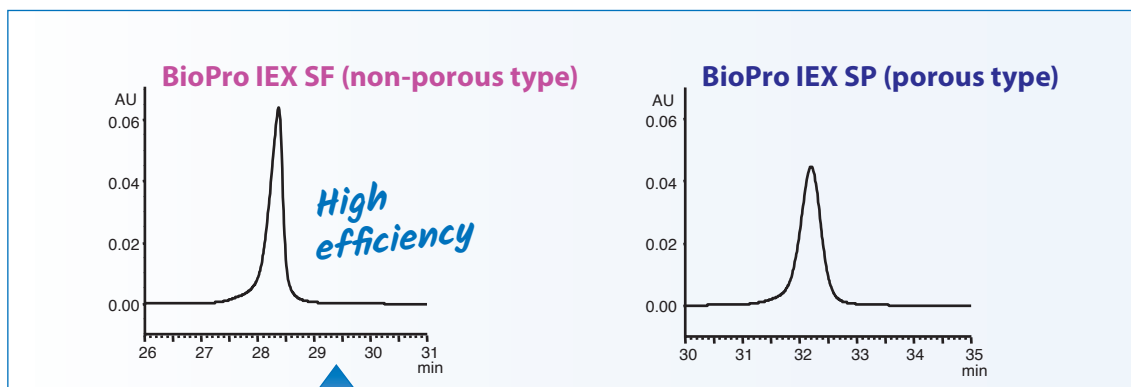

Eluent: A) 20 mM  $\text{NaH}_2\text{PO}_4$ - $\text{Na}_2\text{HPO}_4$  (pH 6.8)  
 B) 20 mM  $\text{NaH}_2\text{PO}_4$ - $\text{Na}_2\text{HPO}_4$  (pH 6.8) containing 0.5 M NaCl  
 Gradient: 0–100%B (0–60 min)  
 Flow rate: 0.5 mL/min  
 Temperature: 25°C

Detection: UV at 280 nm  
 Injection: 100  $\mu\text{L}$   
 Sample: 1. Ribonuclease A  
 2. Cytochrome c  
 3. Lysozyme

**BioPro IEX SF offers outstanding column efficiency at small amount of sample loading. Non-porous type of BioPro IEX columns are especially suitable for microscale analysis which requires higher resolution. BioPro IEX SP maintains the good peak shape even when the loading amount increases. Porous type BioPro IEX columns with high capacity are useful for high-load analytical separations and laboratory-scale purification.**

# IEX – BioPro IEX: Challenging separations

## Protein separation in challenging matrices

### Separation of proteins in human serum on BioPro IEX QA and commercial Q-type products

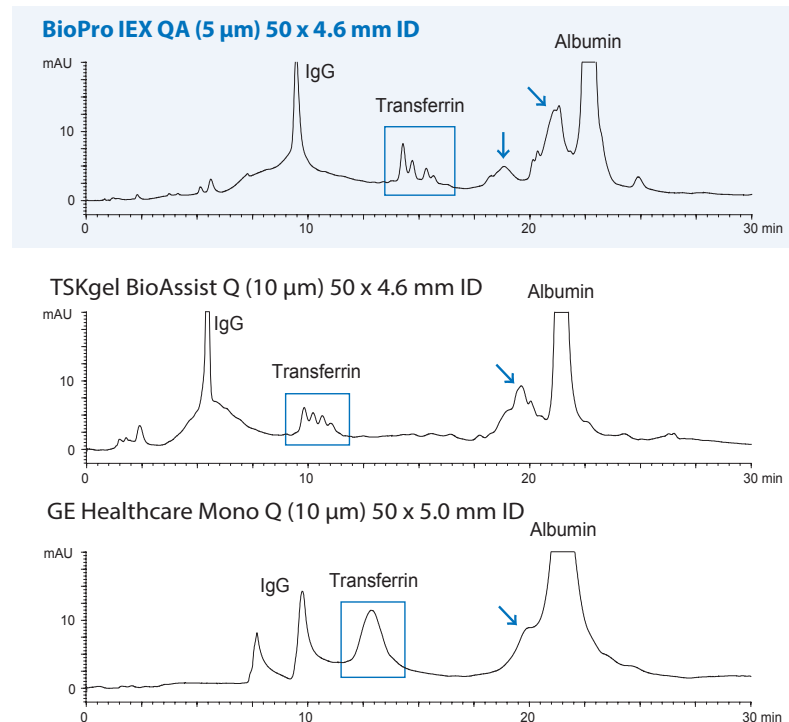

*For high resolution porous BioPro IEX QA/SP is recommended!*

Part No.:	QAA0S05-0546WP	Flow rate:	0.5 mL/min
Eluent:	A) 20 mM Tris-HCl (pH 8.6) B) 20 mM Tris-HCl (pH 8.6) containing 0.5 M NaCl	Temperature:	25 °C
Gradient:	0–30%B (0–15 min), 30–100%B (15–30 min)	Detection:	UV at 280 nm
		Injection:	20 μL
		Sample:	Human serum (100 μL/mL)

## Better performance at lower backpressure

### Comparison of standard protein separation on BioPro IEX SF and a commercial SP-type product

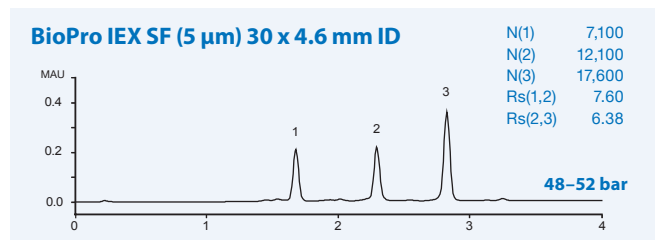

BioPro IEX SF elutes the proteins in sharper peaks without peak-tailing compared to TSKgel SP-NPR. Despite the larger particle size, the theoretical plate count for BioPro IEX SF is higher than that for TSKgel SP-NPR.

*higher plate count*

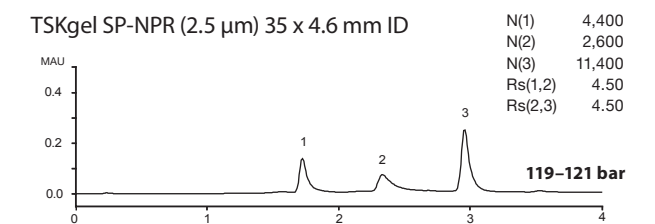

Part No.:	SF00S05-0346WP
Eluent:	A) 20 mM KH <sub>2</sub> PO <sub>4</sub> -K <sub>2</sub> HPO <sub>4</sub> (pH 6.8) B) 20 mM KH <sub>2</sub> PO <sub>4</sub> -K <sub>2</sub> HPO <sub>4</sub> (pH 6.8) containing 0.5 M NaCl
Gradient:	BioPro IEX SF 0-100%B (0–4 min) TSKgel SP-NPR 0-100%B (0–4.67 min)
Flow rate:	1.5 mL/min
Temperature:	25 °C
Detection:	UV at 220 nm
Injection:	20 μL
Sample:	1. Ribonuclease A (0.1 mg/mL) 2. Cytochrome c (0.1 mg/mL) 3. Lysozyme (0.1 mg/mL)

Compared to the competitor's column, BioPro IEX SF gives higher theoretical plate counts, excellent peak shapes, and lower backpressures. This makes BioPro IEX SF most suitable for high-throughput analysis.



## Peptide mapping

### Peptide mapping of tryptic digests of BSA with enhanced sensitivity

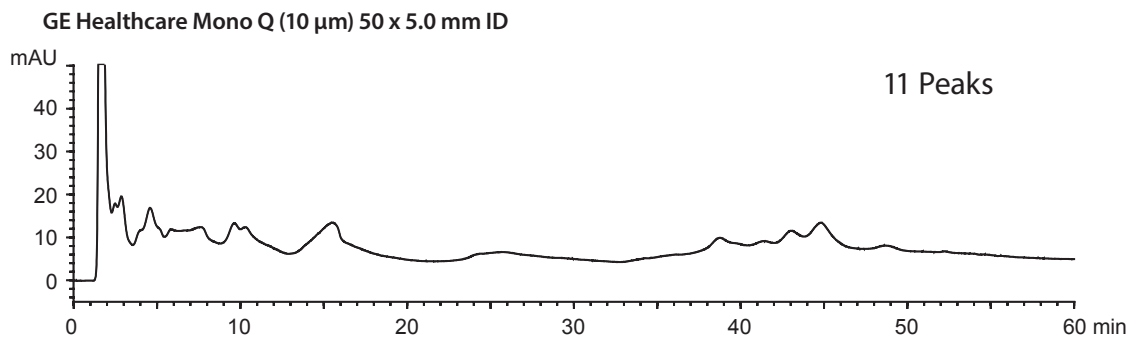
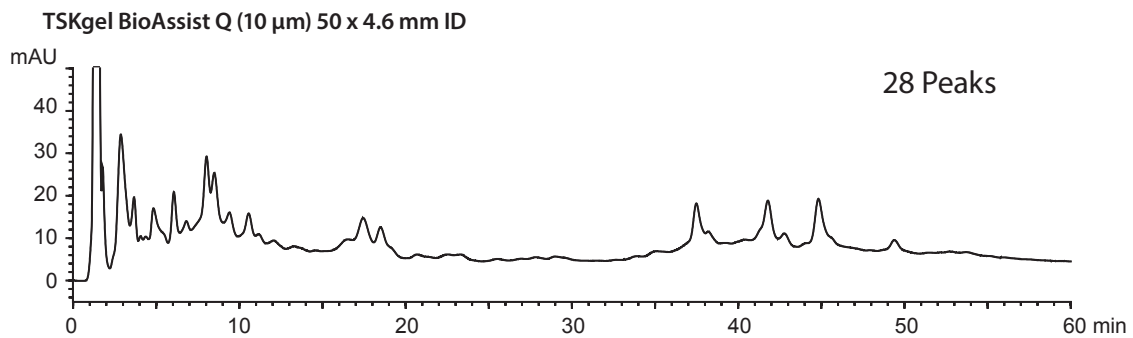
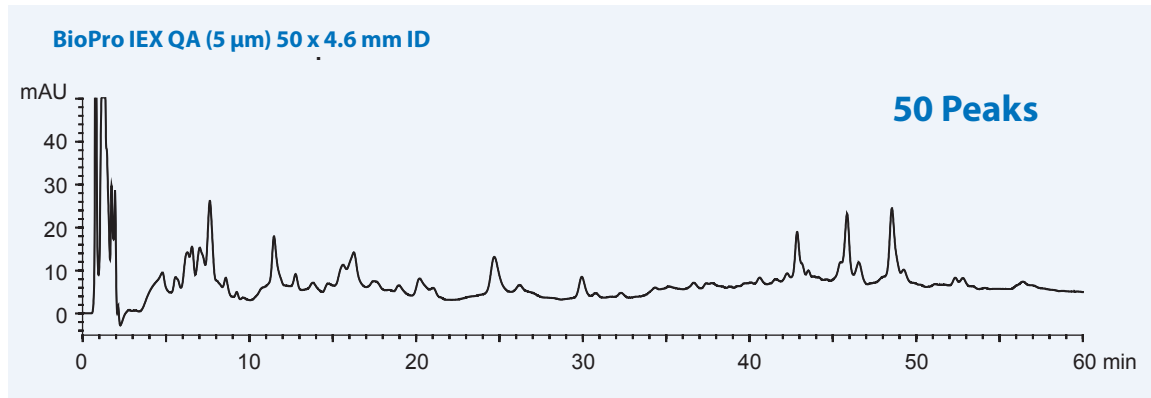

Part No.: QAA0S05-0546WP  
 Eluent: A) 20 mM Tris-HCl (pH 8.6)  
 B) 20 mM Tris-HCl (pH 8.6) containing 0.5 M NaCl  
 Gradient: 0–15%B (0–30 min), 15–60%B (30–60 min)  
 Flow rate: 0.5 mL/min  
 Temperature: 25 °C  
 Detection: UV at 220 nm  
 Injection: 20 µL  
 Sample: Tryptic digest of BSA

# IEX – BioPro IEX: Antibody analysis

## Monoclonal antibody analysis with non-porous cation exchange columns

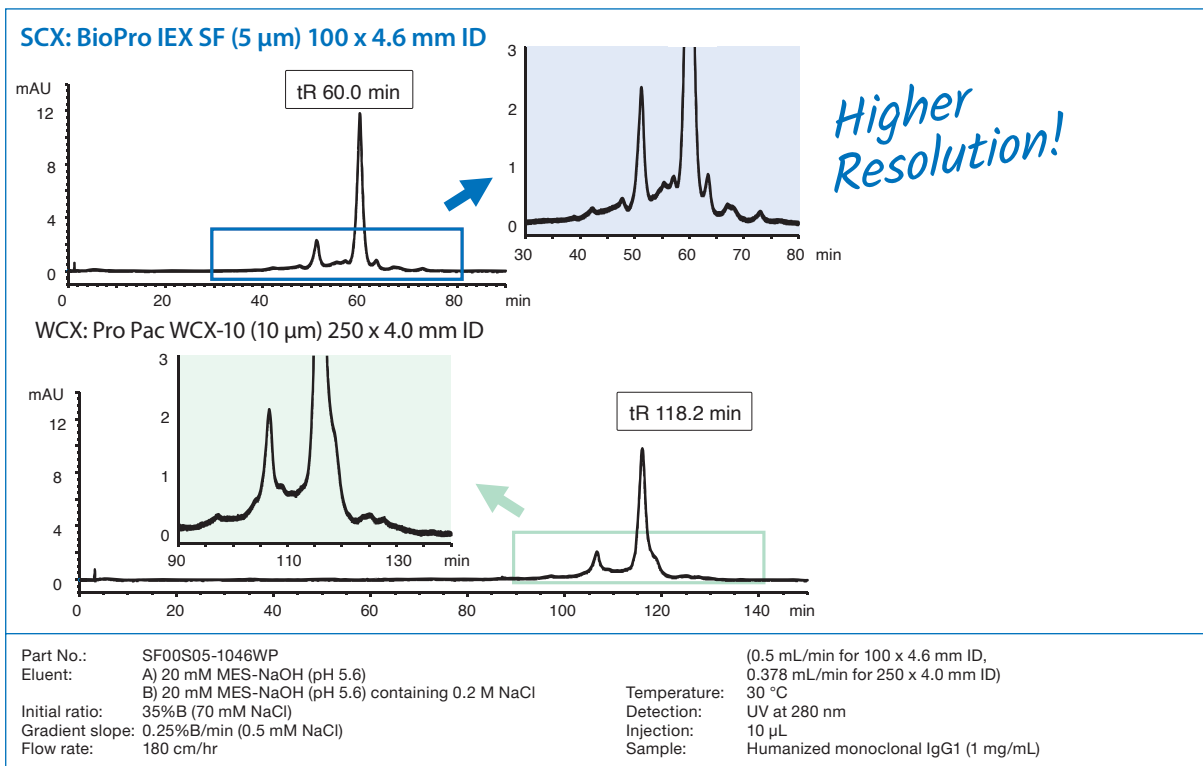

The separation of MAb is compared using a strong cation (BioPro IEX SF) and a weak cation exchange column (ProPac WCX-10) under the same gradient conditions at pH 5.6. BioPro IEX SF can achieve a higher resolution of MAB than the competitor's column in a shorter analysis time.

## QC of monoclonal antibodies with non-porous BioPro IEX QF

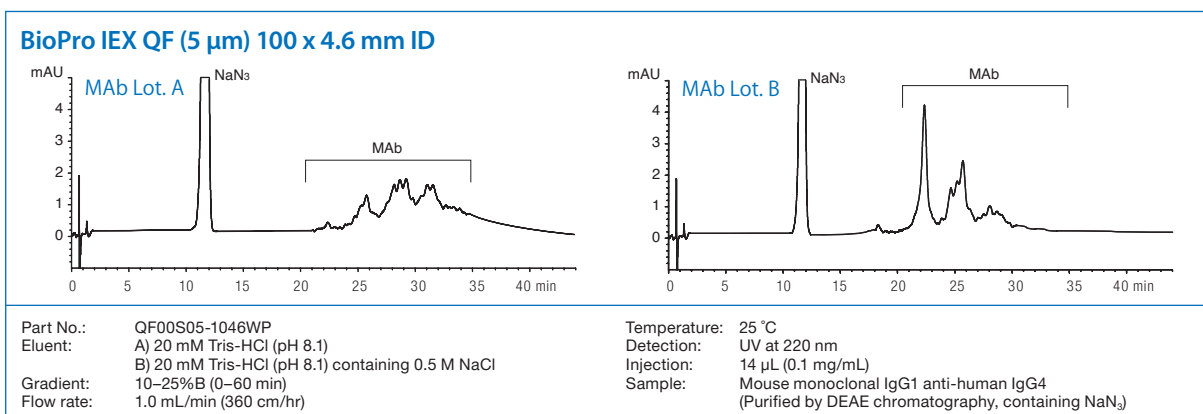

Two different batches of commercially available MAb purified by DEAE chromatography were analyzed on a BioPro IEX QF column (100 mm length). The MAB was separated into several peaks, and the batch-to-batch variability is observed. The BioPro IEX QF/SF 100 mm length columns, which have high efficiency, are ideal for characterization of glycoproteins, such as monoclonal antibodies, and for quality control assessment of biopharmaceuticals.

## Optimisation of oligonucleotide separations on ion exchange chromatography

Non-porous anion exchange column is generally suitable for analysis of oligonucleotides. For optimisation of single-stranded DNA and RNA of about 20 mer some conditions such as type of mobile phase and column temperature can be changed.

### 1 Improvement of peak tailing

#### Sample Group 1 (Phosphodiester oligonucleotides; PO)

1	Single-stranded DNA (ssDNA)	5'-TCATCACACTGAATACCAAT-3' (DNA 20 mer)
2	Single-stranded DNA (ssDNA)	5'-GTCATCACACTGAATACCAAT-3' (DNA 21 mer)
3	Single-stranded RNA (ssRNA)	5'-UCAUCACACUGAAUACCAU-3' (RNA 20 mer)
4		5'-GUCAUCACACUGAAUACCAU-3' (RNA 21 mer)
5	Single-stranded RNA (ssRNA)	5'-U(M)C(M)A(M)U(M)C(M)A(M)C(M)A(M)C(M)U(M)G(M)A(M)A(M)U(M)A(M)C(M)C(M)A(M)A(M)U(M)-3' (2'-OMe RNA 20 mer)
6		5'-G(M)U(M)C(M)A(M)U(M)C(M)A(M)C(M)A(M)C(M)U(M)G(M)A(M)A(M)U(M)A(M)C(M)C(M)A(M)A(M)U(M)-3' (2'-OMe RNA 21 mer)

N(M)=2'-OMe RNA

By changing the buffer from 20 mM Tris-HCl (pH 8.1) to 10 mM NaOH, the tailing factor for an oligonucleotide is reduced. Furthermore, the peak tailing is further suppressed when NaClO<sub>4</sub> was added to 10 mM NaOH instead of NaCl.

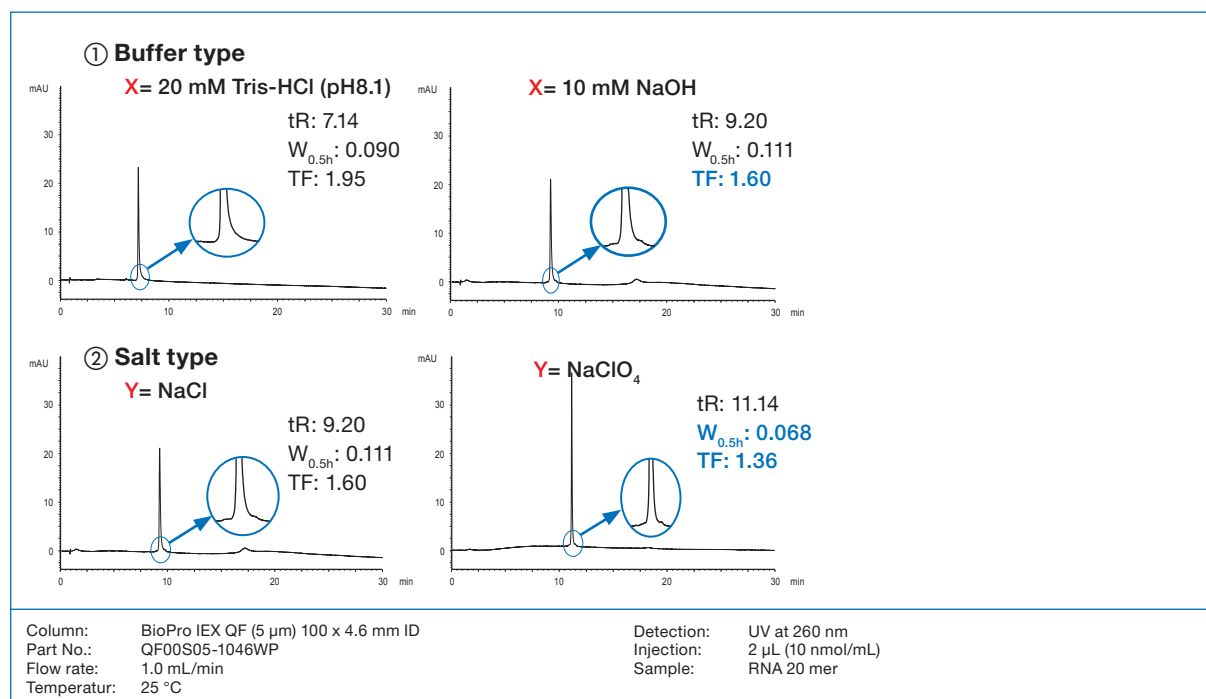

### 2 Improvement of carryover

When the initial gradient concentration of NaCl is low (ex. 50 mM), carryover is observed. By increasing the initial gradient concentration of NaCl up to 400 carryover can be avoided with good reproducibility.

## IEX – Expert Tips: Oligonucleotides

### 3 Improvement of ssDNA separation with single-base differences (differing in the type of base of 5'end of DNA 21mer)

When ssDNAs with single-base differences (differing in the type of base of 5'end of DNA 21mer) is analysed under the described condition, all of peak separations got worse. By using a shallower gradient, better separations could be achieved.

1	Single-stranded DNA	5'-TCATCACACTGAATACCAAT-3' (DNA 20 MER)
2		5'-GTCATCACACTGAATACCAAT-3' (DNA 21 MER)
7		5'-ATCATCACACTGAATACCAAT-3' (DNA 21 MER)
8		5'-CTCATCACACTGAATACCAAT-3' (DNA 21 MER)
9		5'-TTCATCACACTGAATACCAAT-3' (DNA 21 MER)

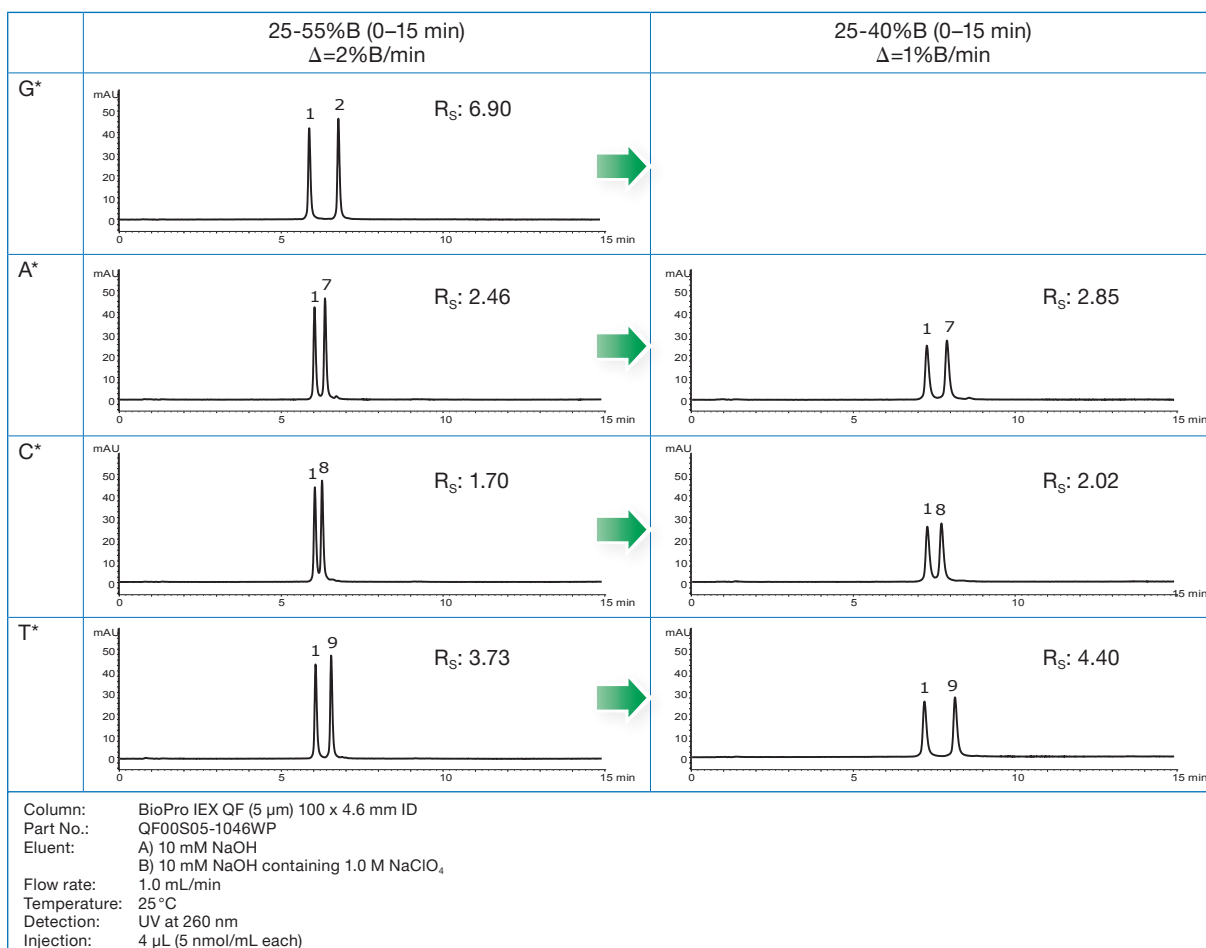

\*base of 5'end of DNA 21 mer

### 4 Improvement of the separation of phosporothioate oligonucleotides with single-base differences in length

Since acidity of all PS is much higher than all PO, a higher salt concentration is required for elution. The peak of all PS is much broader because it is thought that all PS contains as many as 219 (524,288) stereoisomers. A steeper gradient curve, increasing column temperature and adding organic solvent can improve peak separation. However, increase of organic solvent ratio gave little improvement in peak separation.



## IEX – Ordering information

### 3 µm non-porous analytical columns, PEEK hardware (max. pressure 250 bar)

Phase	Column ID [mm]	Column length [mm]				Precolumn filter 2 µm* (pack of 5)
		30 (250 bar)	50 (250 bar)	100 (250 bar)	150 (250 bar)	
BioPro IEX QF	4.6	QF00S03-0346WP	QF00S03-0546WP	QF00S03-1046WP	QF00S03-1546WP	XRPRCP25
BioPro IEX SF	4.6	SF00S03-0346WP	SF00S03-0546WP	SF00S03-1046WP	SF00S03-1546WP	

### 5 µm non-porous analytical columns, PEEK hardware (max. pressure 60–120 bar)

Phase	Column ID [mm]	Column length [mm]				Precolumn filter 2 µm* (pack of 5)
		30 (60 bar)	50 (100 bar)	100 (120 bar)	150 (120 bar)	
BioPro IEX QF	4.6	QF00S05-0346WP	QF00S05-0546WP	QF00S05-1046WP	QF00S05-1546WP	XRPRCP25
BioPro IEX SF	4.6	SF00S05-0346WP	SF00S05-0546WP	SF00S05-1046WP	SF00S05-1546WP	

### 5 µm porous analytical columns, PEEK hardware (max. pressure 25–35 bar)

Phase	Column ID [mm]	Column length [mm]			Precolumn filter 2 µm* (pack of 5)
		30 (25 bar)	50 (30 bar)	100 (35 bar)	
BioPro IEX QA	4.6	QAA0S05-0346WP	QAA0S05-0546WP	QAA0S05-1046WP	XRPRCP25
BioPro IEX SP	4.6	SPA0S05-0346WP	SPA0S05-0546WP	SPA0S05-1046WP	

\* Holder required, part no. XRPRCP02

### 6 µm non-porous semiprep. columns, stainless steel hardware (max. pressure 30–90 bar)

Phase	Column ID [mm]	Column length [mm]	
		100	
BioPro IEX QF	10	QF00S06-1010WT	
	20	QF00S06-1020WT	
	30	QF00S06-1030WT	
BioPro IEX SF	10	SF00S06-1010WT	
	20	SF00S06-1020WT	
	30	SF00S06-1030WT	

### 6 µm porous semiprep. columns, stainless steel hardware (max. pressure 40 bar)

Phase	Column ID [mm]	Column length [mm]	
		100	
BioPro IEX QA	10	QAA0S06-1010WT	
	20	QAA0S06-1020WT	
BioPro IEX SP	10	SPA0S06-1010WT	
	20	SPA0S06-1020WT	

Other dimensions on demand



HIC

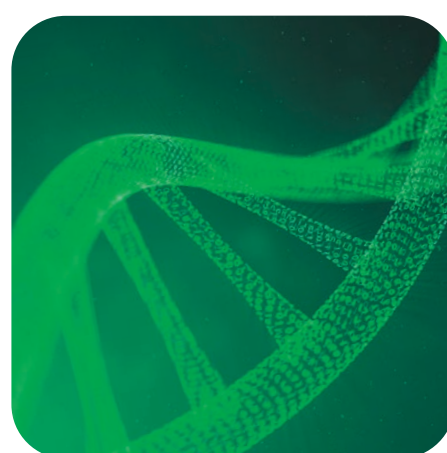
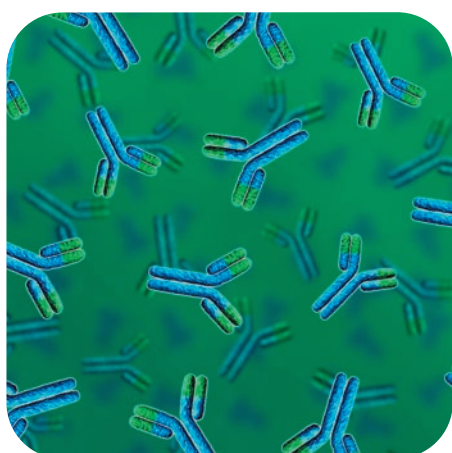

# HIC – BioPro Series

- Specifically designed for drug-to-antibody conjugates (ADCs) and antibodies
- Ideal drug-to-antibody ratio (DAR) analysis
- High throughput by reducing analysis time
- Excellent batch-to-batch reproducibility
- Long term stability

	BioPro HIC HT	BioPro HIC BF
Base particle	hydrophilic polymer (polymethacrylate)	hydrophilic polymer (polymethacrylate)
Particle size / $\mu\text{m}$	2.3	4
Pore	non-porous	non-porous
Functional group	butyl	butyl
pH range	2–12	2–12
Pressure limit	40 MPa (5,800 psi)	20 MPa (2,900 psi)
Temperature range	10–60°C	10–60°C

## High column stability

High throughput by shortening analysis time using high flow rates

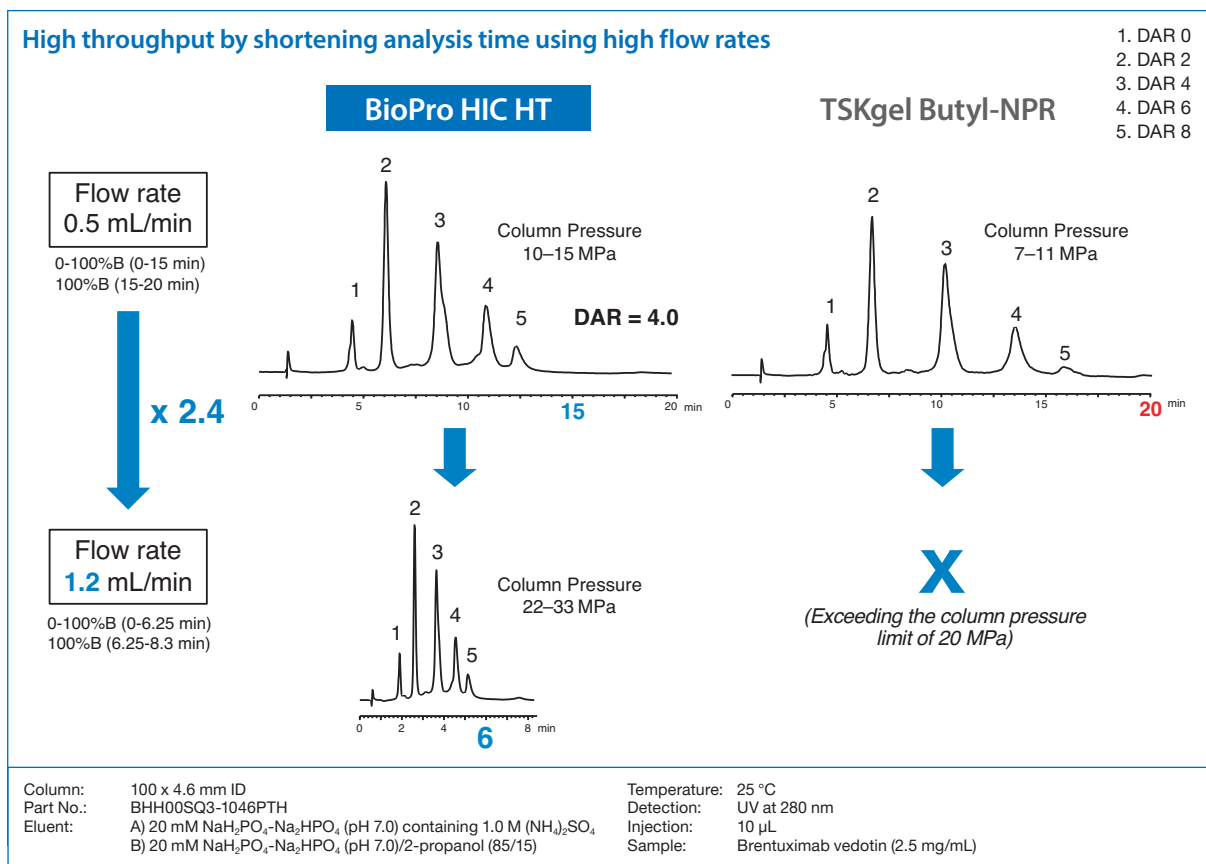

**BioPro HIC HT improves analysis throughput of ADCs by 2–3 times with an excellent Drug-to-Antibody Ratio (DAR). The rapid analysis is possible without loss of resolution. Competitor HIC columns fail under these conditions.**



# HIC – BioPro HIC: Reproducibility & stability

## Excellent batch-to-batch reproducibility

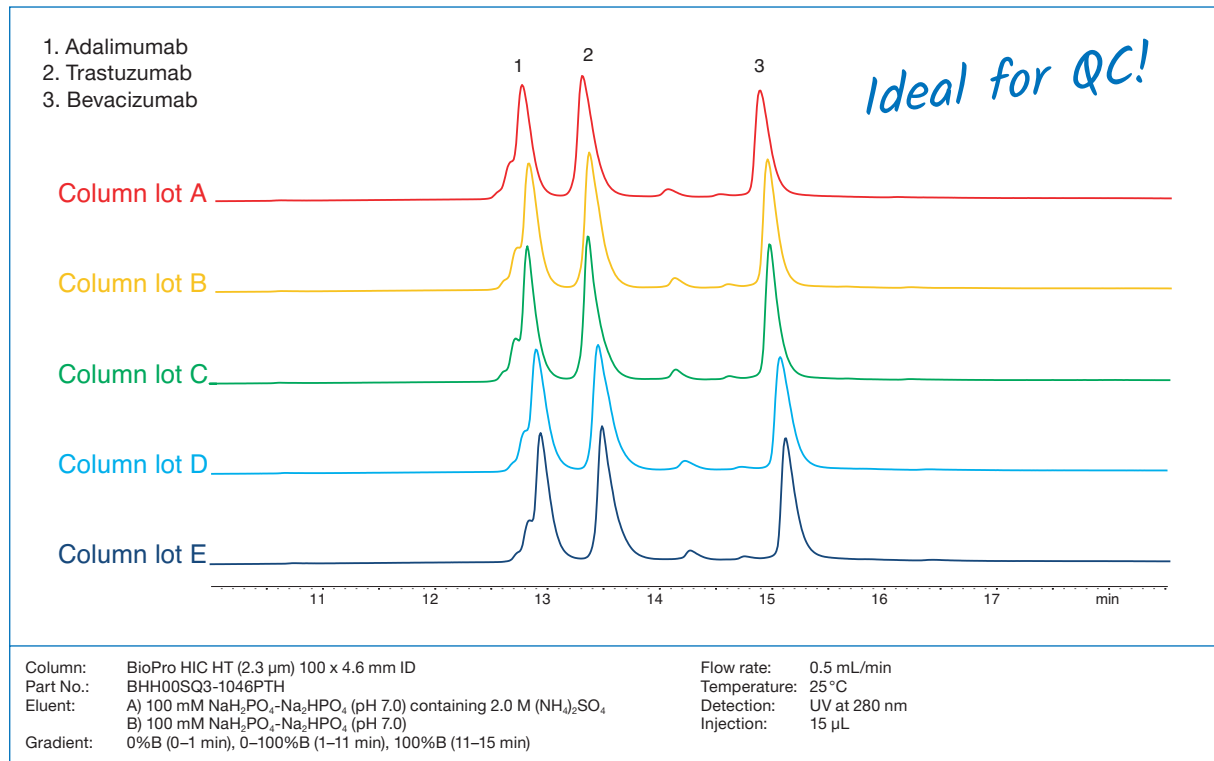

BioPro HIC HT exhibits an excellent batch-to-batch reproducibility making it the ideal choice for quality control analysis of biopharmaceuticals such as MAbs.

## Exceptional stability

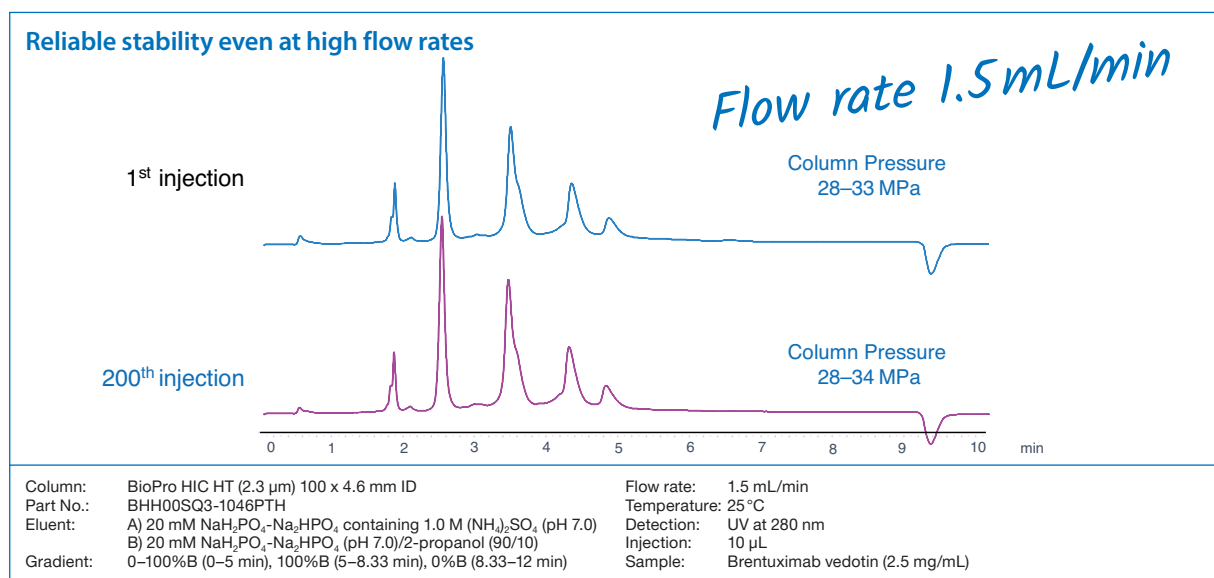

BioPro HIC HT offers excellent stability under high flow rates/high pressure conditions due to its unique rigid particle and optimised column packing technology.

# HIC – BioPro HIC: ADC analysis

## Designed for analysis of ADCs

Novel surface chemistry for drug-to-antibody ratio (DAR) analysis

1. DAR 0
2. DAR 2
3. DAR 4
4. DAR 6
5. DAR 8

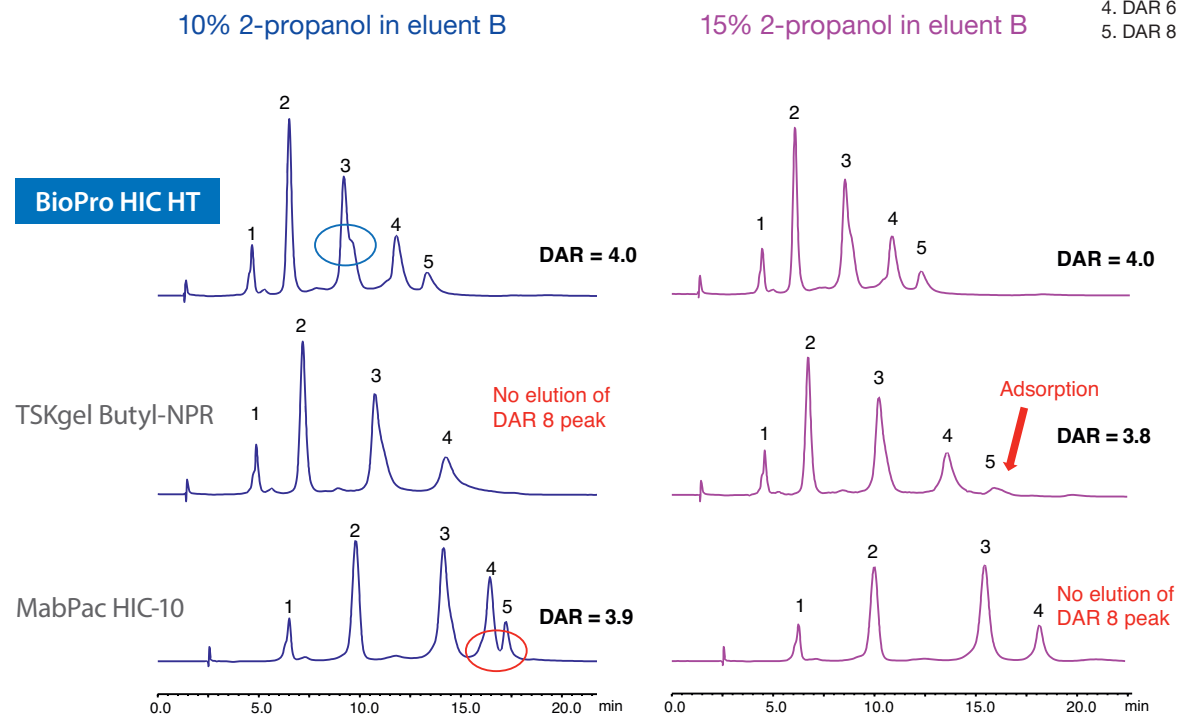

Column: 100 x 4.6 mm ID  
 Part No.: BHH00SQ3-1046PTH  
 Eluent: A) 20 mM NaH<sub>2</sub>PO<sub>4</sub>-Na<sub>2</sub>HPO<sub>4</sub> (pH 7.0) containing 1.0 M (NH<sub>4</sub>)<sub>2</sub>SO<sub>4</sub>  
 B) 20 mM NaH<sub>2</sub>PO<sub>4</sub>-Na<sub>2</sub>HPO<sub>4</sub> (pH 7.0)/2-propanol (90/10) or (85/15)  
 Gradient: 0–100%B (0–15 min), 100%B (15–20 min), 0%B (20–35 min)  
 Flow rate: 0.5 mL/min  
 Temperature: 25 °C  
 Detection: UV at 280 nm  
 Injection: 10 µL  
 Sample: Brentuximab vedotin (2.5 mg/mL)

BioPro HIC HT offers higher resolution than conventional HIC columns. Its surface modification suppresses excessive or too strong adsorption of ADCs and results in highly reliable quantification. With varying 2-propanol content, all peaks are completely eluted from the BioPro HIC HT column with high resolution. Another peak is partially separated from peak 3. Additionally, the same DAR values are observed at any content of 2-propanol.

### BioPro HIC HT offers:

- Higher resolution than conventional HIC columns
- Highly reliable quantification
- Flexible method development

## Excellent recovery and virtually no carry over

### Highly accurate quantification of ADCs and antibodies

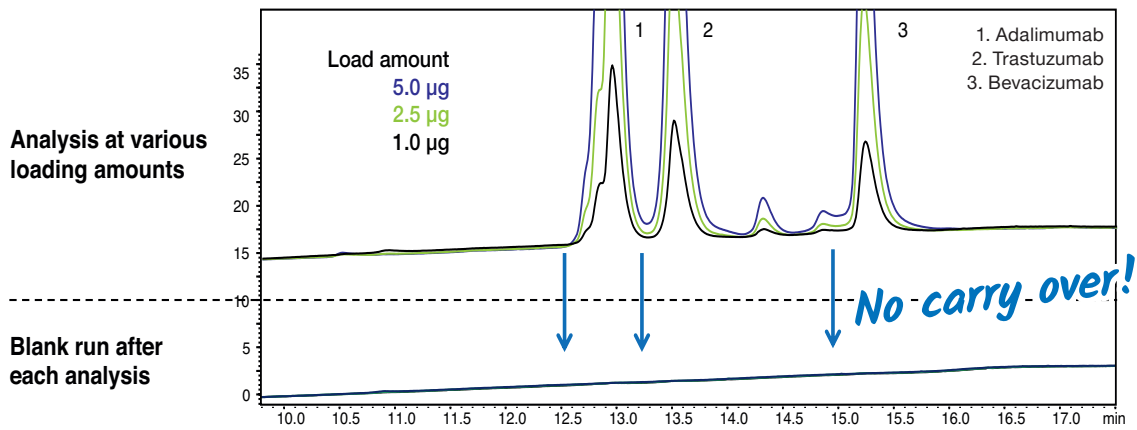

Column: BioPro HIC HT (2.3 µm) 100 x 4.6 mm ID  
 Part No.: BHH00SQ3-1046PTH  
 Eluent: A) 100 mM NaH<sub>2</sub>PO<sub>4</sub>-Na<sub>2</sub>HPO<sub>4</sub> (pH 7.0) containing 2.0 M (NH<sub>4</sub>)<sub>2</sub>SO<sub>4</sub>  
 B) 100 mM NaH<sub>2</sub>PO<sub>4</sub>-Na<sub>2</sub>HPO<sub>4</sub> (pH 7.0)

Gradient: 0%B (0–1 min), 0–100%B (1–11 min), 100%B (11–15 min)  
 Flow rate: 0.5 mL/min  
 Temperature: 25 °C  
 Detection: UV at 280 nm

BioPro HIC HT offers higher linearity over wide loading and virtually no carryover. This contributes to highly accurate quantitation of ADCs and antibodies.

## Different hydrophobicity

### The right column for each separation

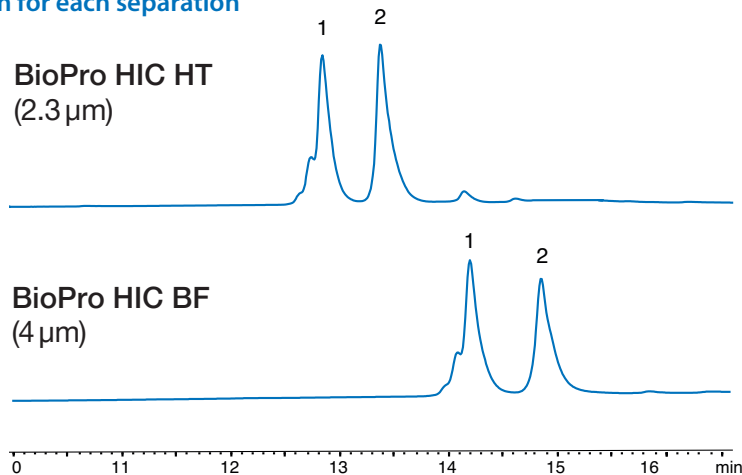

Column: 100 x 4.6 mm ID  
 Part Nos.: BHH00SQ3-1046PTH  
 BHB00S04-1046WT  
 Eluent: A) 100 mM NaH<sub>2</sub>PO<sub>4</sub>-Na<sub>2</sub>HPO<sub>4</sub> (pH 7.0) containing 2.0 M (NH<sub>4</sub>)<sub>2</sub>SO<sub>4</sub>  
 B) 100mM NaH<sub>2</sub>PO<sub>4</sub>-Na<sub>2</sub>HPO<sub>4</sub> (pH 7.0)  
 Gradient: 0%B (0–1 min), 0–100%B (1–11 min), 100%B (11–15 min)

Flow rate: 0.5 mL/min  
 Temperature: 25 °C  
 Detection: UV at 280 nm  
 Injection: 15 µL  
 Sample: 1. Adalimumab (Humira®; 0.5 mg/mL)  
 2. Trastuzumab (Herceptin®; 0.5 mg/mL)

BioPro HIC HT is the first choice for ADCs or MABs. BioPro HIC BF columns show a stronger retention and can therefore be used for the separation of low hydrophobic proteins or especially for the analysis of oxidised MABs.

# HIC – BioPro HIC: Direct HIC-MS coupling

## Online native HIC-MS analysis of MABs and their molecular variants

### Separation of an antibody mixture of seven different MABs

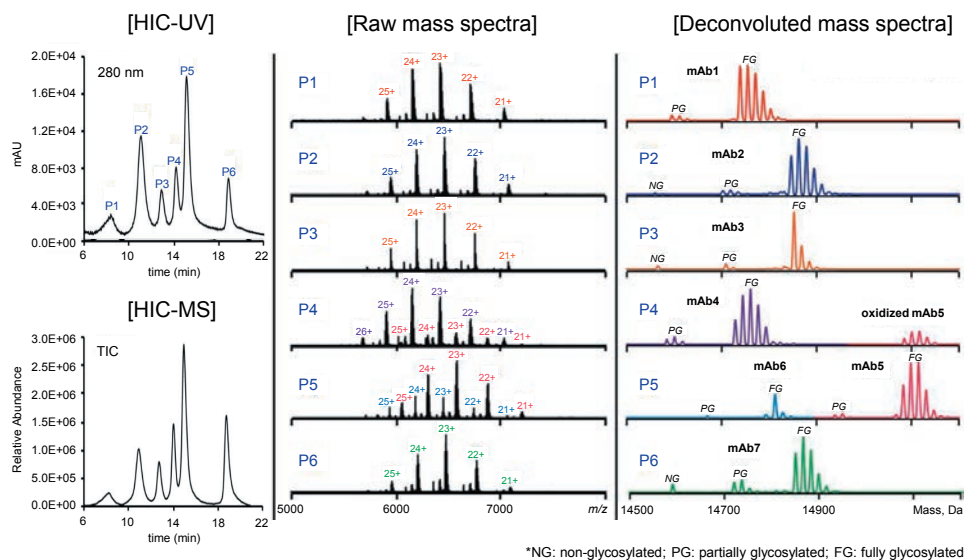

### Separation of two MABs from their molecular variants

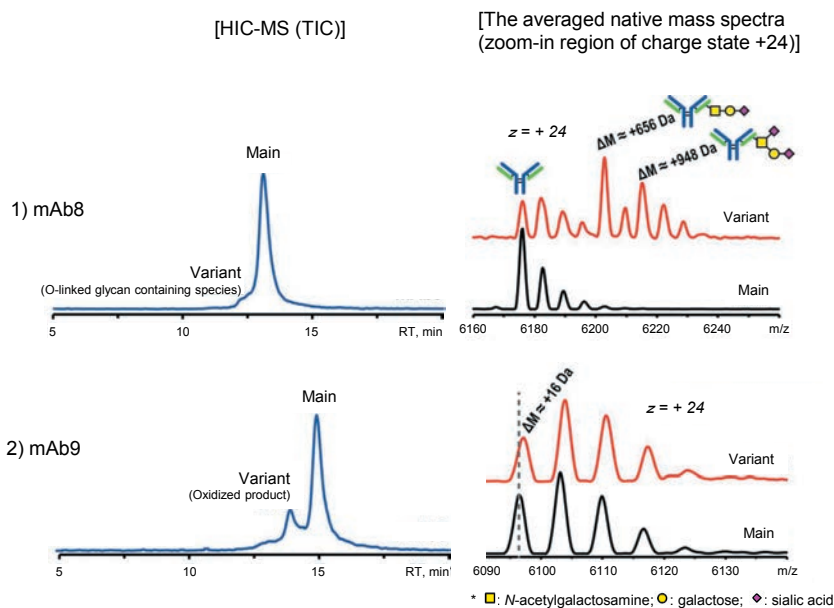

Column: BioPro HIC BF (4  $\mu$ m) 100 x 4.6 mm ID  
 Part No.: BHB00S04-1046WT  
 Eluent: A) 3 M ammonium acetate in water  
 B) 100 % water  
 Gradient: 0% B (0–2 min), 0–90% B (2–18 min), 90% B (18–22 min)  
 Flow rate: 0.3 mL/min  
 Temperature: ambient  
 Detection: UV at 280 nm, NSI-MS

Injection: MAB mixture: 3  $\mu$ L (3–6  $\mu$ g)  
 MAB 8 and MAB 9: 10  $\mu$ g each  
 Sample: Mixture of 7 in-house MABs at 1–2 mg/mL each  
 2 in-house MABs with molecular variants  
 Setup: Post-column makeup flow:  
 100 % water at 1.5 mL/min (reducing salt conc. 6-fold)  
 Splitter to reduce the flow rate to 1–5  $\mu$ L/min

Courtesy by S. Wang, Regeneron Pharmaceuticals Inc.

To enable simultaneous UV and MS detection a post-column makeup flow and a splitter were used. The makeup flow decreases the salt concentration while the splitter reduces the flow rate to enable the coupling to MS. A nanospray ionisation (NSI) was chosen because of its high sensitivity and salt tolerance.

Reference: Y. Yan, T. Xing, S. Wang, T. J. Daly, N. Li, Online coupling of analytical hydrophobic interaction chromatography with native mass spectrometry for the characterization of monoclonal antibodies and related products, J. Pharm. Biomed. Anal. 186 (2020) 113313.

## The influence of salts in HIC separations

The technique known as hydrophobic interaction chromatography is a mode of chromatography that separates proteins by differences in surface hydrophobicity. [1] This method utilises reversible interactions that occur between protein molecules and hydrophobic stationary phase ligands attached to the particle surface.

Certain non-denaturing salts are used to improve the hydrophobic interactions between proteins and the stationary phase. The mobile phase is typically an aqueous solution of salts such as ammonium sulfate or sodium chloride and a buffer to control pH (usually phosphate

buffer between pH 6 and 7). The Hofmeister series of lyotropic and chaotropic ions shown below in Fig. 1 provides a template for salt selection. High concentrations of salt, particularly ammonium sulfate, may precipitate proteins; therefore, solubility should be checked under the initial gradient (binding) conditions. The strength of the interaction between the protein and stationary phase decreases with decreasing salt gradient (see Fig. 2). Another option is a change of pH which results in an increase in the charge on the protein due to the ionisation of acidic groups.

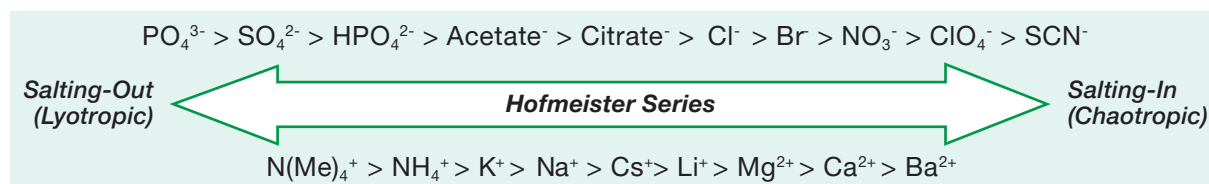

Fig. 1: The Hofmeister Series of lyotropic and chaotropic ions.

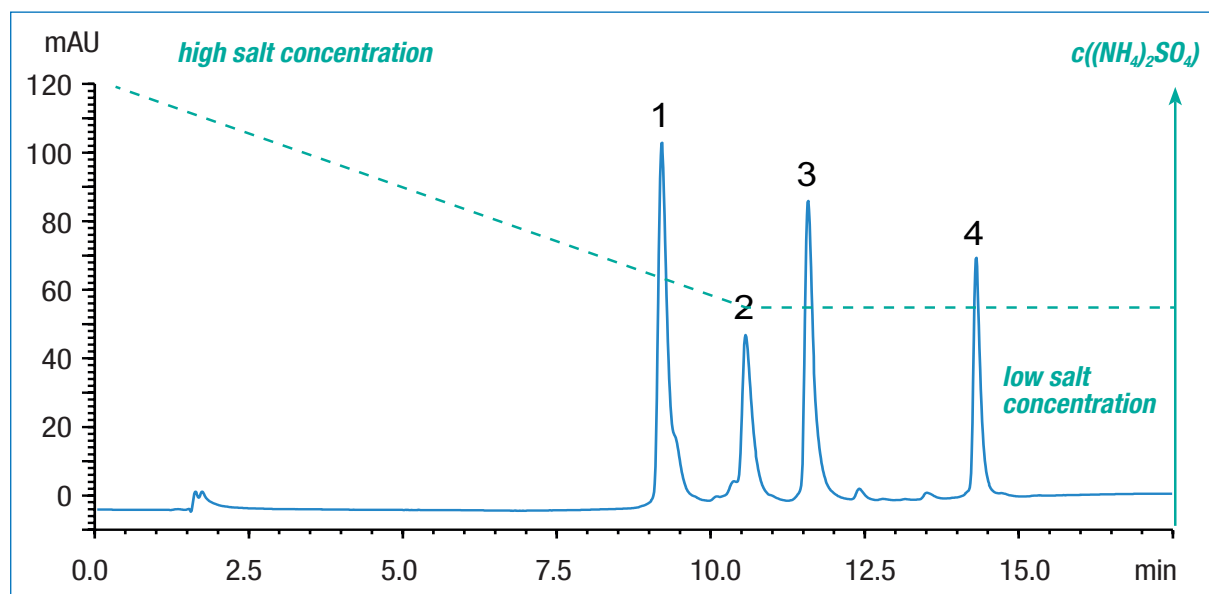

Fig. 2: Method with decreasing salt gradient.

Column:	BioPro HIC BF (100 x 4.6 mm ID)	Samples:	1. Myoglobin (0.73 mg/mL)
Part No.:	BHB00S04-1046WT		2. Ribonuclease A (0.75 mg/mL)
Eluent:	A) 100 mM NaH <sub>2</sub> PO <sub>4</sub> -Na <sub>2</sub> HPO <sub>4</sub> (pH 7.0) containing 2.0 M (NH <sub>4</sub> ) <sub>2</sub> SO <sub>4</sub> B) 100 mM NaH <sub>2</sub> PO <sub>4</sub> -Na <sub>2</sub> HPO <sub>4</sub> (pH 7.0)		3. Lysozyme (0.25 mg/mL)
Flow rate:	0.5 mL/min		4. α-Chymotrypsinogen A (0.25 gm/mL)
Gradient:	0–100%B (0–11 min), 100%B (11–15 min)		
Temperature:	25°C		
Detection:	UV at 280 nm		
Injection:	15 µL		

HIC is particularly effective when used to separate proteins and monoclonal antibodies. The separation of monoclonal antibodies (MAb), MAb aggregates and glycosylated MAbs can be achieved due to their specific hy-

drophobic properties. It also provides an excellent method for determination of drug-to-antibody ratios (DAR) in antibody-drug conjugates (ADCs).

[1] Queiroza, J.A.; Tomaza, C.T.; Cabral, J.M.: Hydrophobic interaction chromatography of proteins, J Biotechnol. 2001, 87, 143-159.

# HIC – Expert Tips: Separation factors

## Effect of initial salt concentration

**B**uffers containing  $(\text{NH}_4)_2\text{SO}_4$  are often used as a mobile phase in HIC mode because  $(\text{NH}_4)_2\text{SO}_4$  has a strong salt-ing-out effect. The higher the initial concentration of  $(\text{NH}_4)_2\text{SO}_4$ , the stronger will be the retention of proteins. Therefore, a buffer with a high salt concentration is more suitable for the separation of low hydrophobic proteins with weak retention.

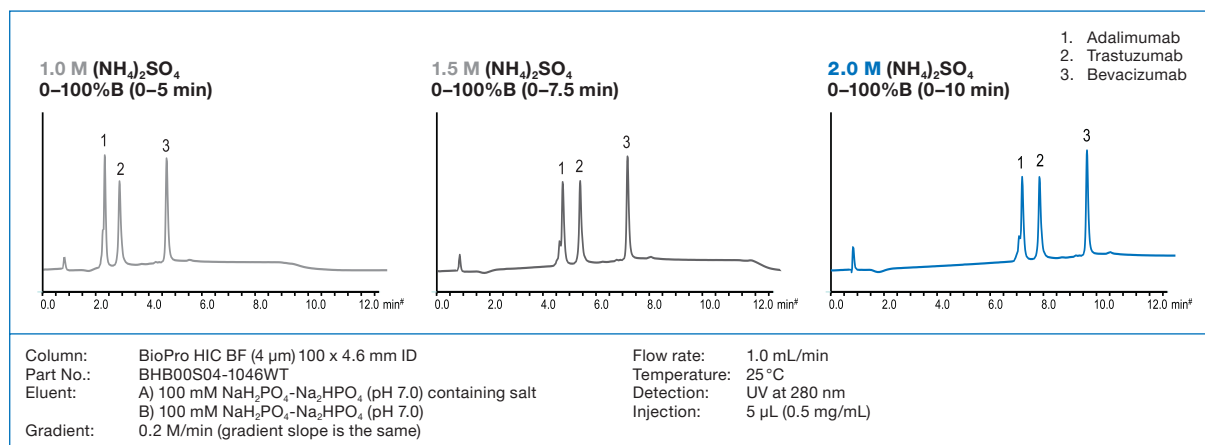

## Influence of the type of salt

**N**aCl and  $\text{CH}_3\text{COONH}_4$  are also used as buffer salts. The separation selectivity varies with the type of salt used in some cases, so changing the type of salt can also be effective when the separation is not sufficient. However, these salts have to be used at very high concentrations to gain retentions comparable to  $(\text{NH}_4)_2\text{SO}_4$ . Attention needs to be paid to the prevention of precipitation of salts in the buffer and damage of the LC system.

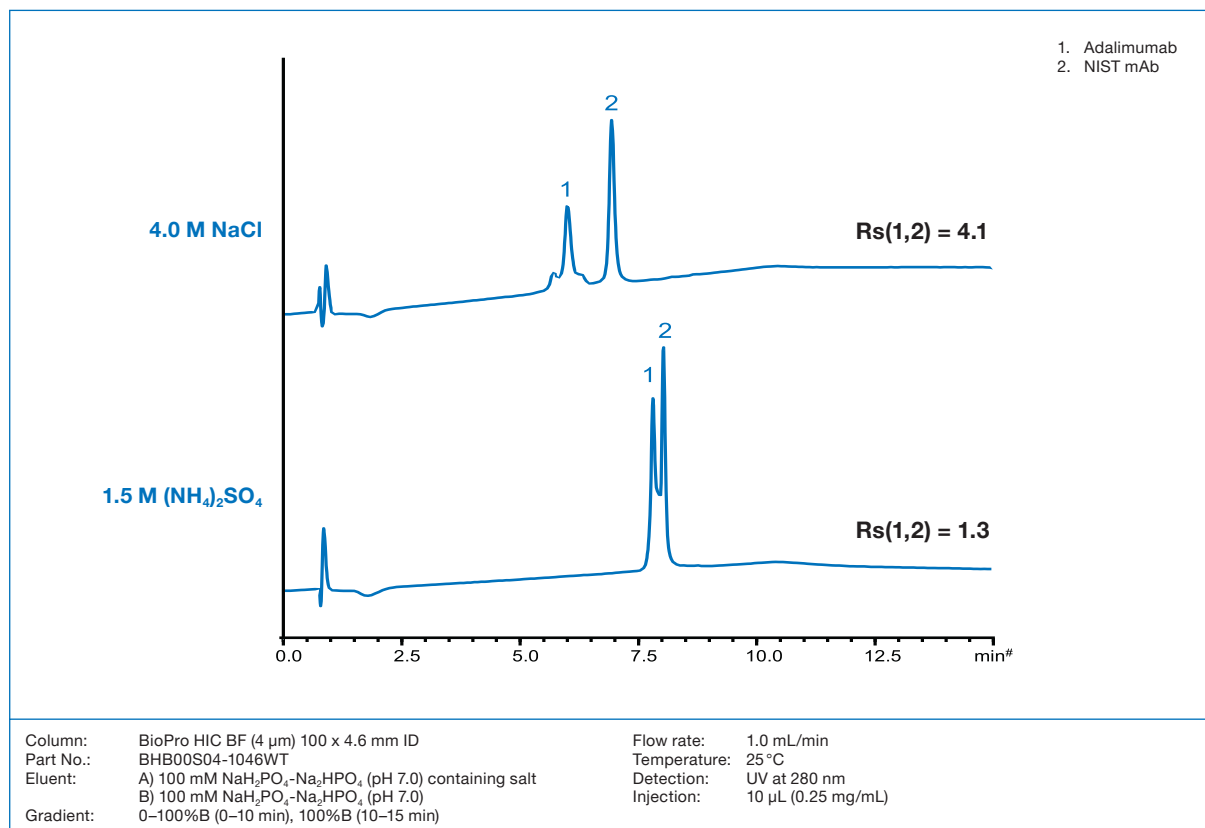

# HIC – Expert Tips: Separation factors / Ordering information

## Temperature influence

In HIC mode, higher temperatures result in longer retention times of proteins. This assumes that the hydrophobic area interacting with the stationary phase becomes larger due to a change in the structure of proteins with increasing temperature, so that the hydrophobic interactions become stronger.

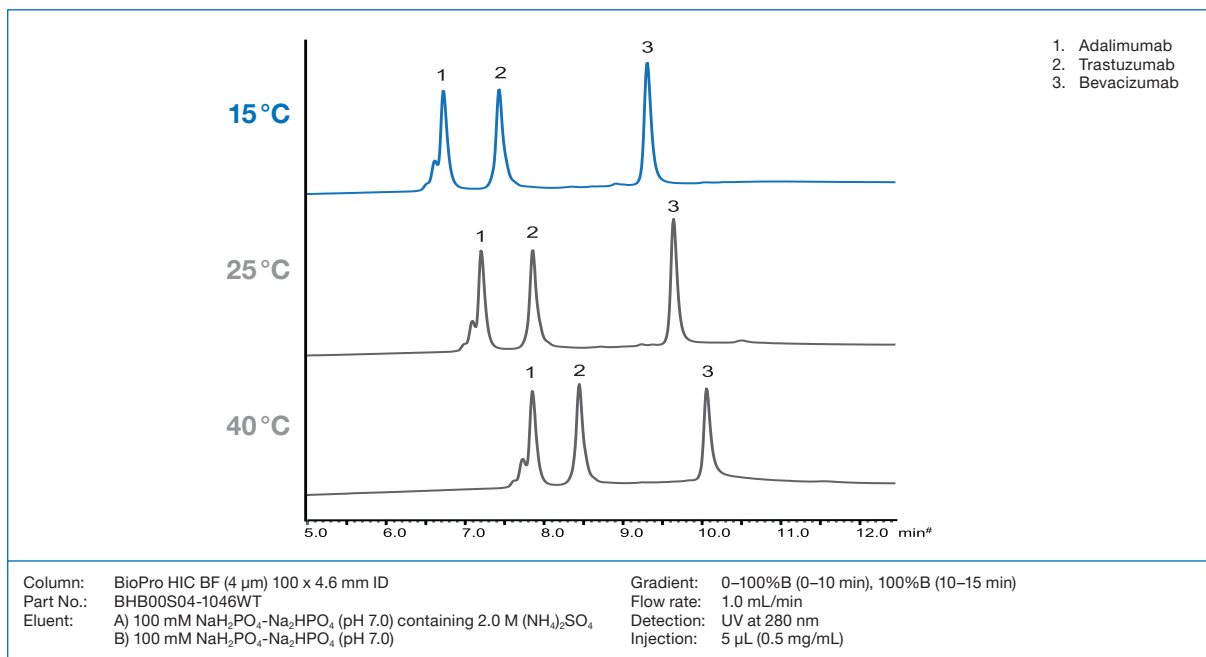

## Variation of gradient slope

In general, shallower gradients improve the separation and the resulting resolution.

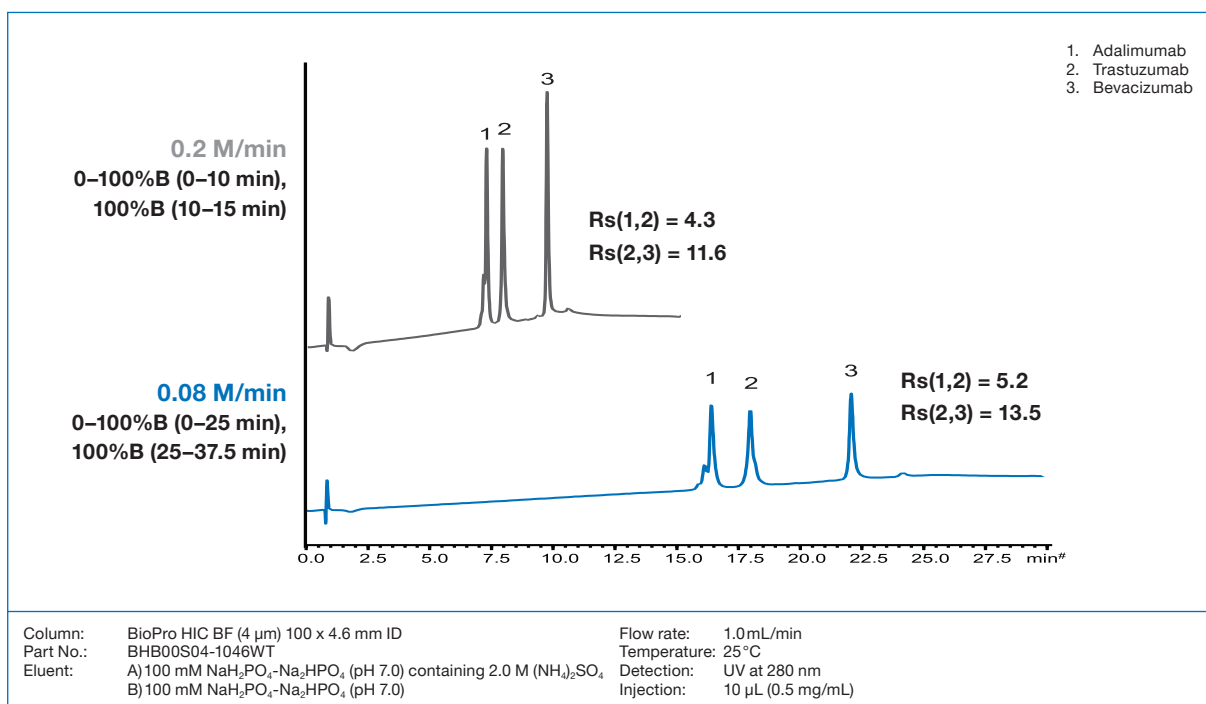

## Ordering information

### Ordering information

Phase	Particle size [µm]	Column ID [mm]	Column length [mm]	Part number	Precolumn filter 2 µm* (pack of 5)
BioPro HIC HT	2.3	4.6	100	BHH00SQ3-1046PTH	XRPRCS35
	2.3	4.6	33	BHH00SQ3-H346PTH	XRPRCS35
BioPro HIC BF	4	4.6	100	BHB00S04-1046WT	XRPRCS35

\*Holder required, part no XRPRCS03  
Other dimensions on demand



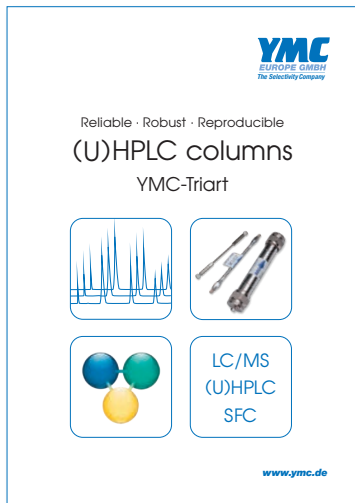

YMC-Triart

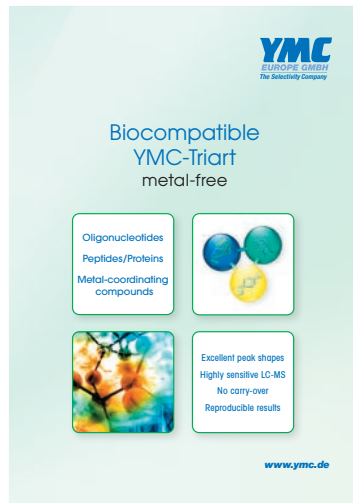

YMC-Triart metal-free



BioPro IEX Resins

## Substance index

<i>Substance</i>	<i>Page</i>	<i>Substance</i>	<i>Page</i>
<b>A</b>		<b>E</b>	
Adalimumab	10, 12, 33, 65, 67, 70, 71,	$\alpha$ -Endorphin	17
Adcetris	13, 14, 64, 65, 66	$\beta$ -Endorphin	17, 29
Adenosindiphosphate	32, 34	$\gamma$ -Endorphin	17
Adenosinmonophosphate	32, 34	[Ala, Met]-Enkephalin	17
Adenosintriphosphate	32, 34	[Ala, Met]-Enkephalinamide	17
ADP	32, 34		
Albumin (human)	15, 16, 44, 56	<b>F</b>	
AMP	32, 34	Fibrinogen	16, 44
Amyloid $\beta$ (human)	17	$\gamma$ -Globulin	16, 44, 49
$\alpha$ 1-Antitrypsin	16, 44		
Arzerra	10	<b>G</b>	
ATP	32, 34	Glucose	44
Avastin	8, 10, 27, 28, 45, 46, 65, 67, 70, 71		
<b>B</b>		<b>H</b>	
BAM-12P	17	Hemoglobin (bovine), tryptic digest	18
Bevacizumab	8, 10, 27, 28, 45, 46, 65, 67, 70, 71	Herceptin	10, 65, 67, 70, 71
Bovines Serumalbumin	15, 25, 26	HSA	15, 16, 44, 56
Brentuximab	12	Humira	10, 12, 33, 65, 67, 70, 71
Brentuximab vedotin	13, 14, 64, 65, 66		
BSA	15, 25, 26	<b>I</b>	
BSA, tryptic digest	18, 57	IgA (human)	16, 44
<b>C</b>		IgG (human)	8, 9, 15, 16, 44, 53, 56
Carbonic anhydrase	16, 44	IgG1 (humanised)	47, 48, 49, 58
$\alpha$ -Chymotrypsinogen A	15, 25, 29, 69	IgG1 (mouse)	11
Cinquaero	12	IgG1 Fab fragment (human)	8, 9
Conalbumin	15	IgG1 FC fragment (human)	8, 9
Creatinine	16	IgM (human)	16, 44
Cytochrome c (horse)	15, 25, 44, 54, 55, 56	Insulin (bovine)	15, 25, 29
<b>D</b>		<b>K</b>	
$\alpha$ -Defensin-1 (human)	17	Keytruda	12
$\alpha$ -Defensin-2 (human)	17	Kynamro	20
$\alpha$ -Defensin-3 (human)	17		

<b>Substance</b>	<b>Page</b>	<b>Substance</b>	<b>Page</b>
<b>L</b>		Phosphorothioate oligonucleotides	19, 61
$\alpha$ -Lactalbumin	44	Plasmid pBR322	20
Lactoferrin	26	Plasmid pBR322, digest	20
$\beta$ -Lactoglobulin A	15, 25, 29	Pullulan (P5-800)	44
Leu-Enkephalin	17, 29		
Lysozyme	15, 16, 29, 54, 55, 56, 69	<b>R</b>	
mAb Subunit Standard	9	Reslizumab	12
		Ribonuclease A	15, 44, 54, 55, 56, 69
		Rituximab	10
<b>M</b>			
MabThera	10	<b>S</b>	
Maltoheptaose	44	Serum (human)	16, 56
Maltopentadecaose	44	SigmaMab antibody drug conjugate mimic	14, 45
Maltopentaose	44	single-strand DNA	18, 60
Maltose	44	Somatropin	30
Maltotriose	44	Synagis	10
Maltoundecaose	44		
Met-Enkephalin	17	<b>T</b>	
Mipomersen	20	Thyroglobulin	44, 49
miRNA	19	Transferrin	15, 16, 25, 44, 56
Myoglobin	44, 49, 69	Trastuzumab	10, 65, 67, 70, 71
		Trypsin Inhibitor	44
<b>N</b>			
Neurotensin	17	<b>U</b>	
NIST MAb	10, 11, 12, 28, 33, 70	Uric acid	16
<b>O</b>			
Ofatumumab	10	<b>V</b>	
Oligodeoxythymidylic acid [d(pT)2-20]	18, 31, 36	Vectibix	10
Oligonucleotide(s), synthetic	18, 19, 31	Vitamin B12	49
Ovalbumin	15, 26, 44, 49		
Oxytocin	17, 29		
<b>P</b>			
Palivizumab	10		
Panitumumab	10		
Pembrolizumab	12		
Phosphodiester oligonucleotides	59		

Your local distributor:

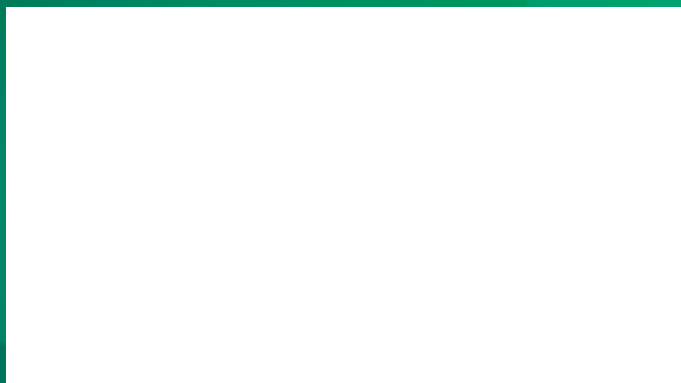

**YMC Europe GmbH**

Schöttmannshof 19  
D-46539 Dinslaken  
Germany  
Phone +49(0)2064 427-0, Fax +49(0)2064 427-222  
[www.ymc.de](http://www.ymc.de)

**YMC Schweiz GmbH**

Im Wasenboden 8  
4056 Basel  
Switzerland  
Phone +41(0)61 561 8050, Fax +41(0)61 561 8059  
[www.ymc-schweiz.ch](http://www.ymc-schweiz.ch)

**YMC CO., LTD.**

YMC Karasuma-Gojo Bld. 284 Daigo-cho,  
Karasuma Nishiiru Gojo-dori Shimogyo-ku,  
Kyoto 600-8106 Japan  
Phone +81(0)75 342 4515, Fax +81(0)75 342 4550  
[www.ymc.co.jp](http://www.ymc.co.jp)